

A00

ArcelorMittal's range

Last update: 2015-3-17



Introduction

This section presents ArcelorMittal's wide range of hot rolled steels. Each steel family has properties that have been optimised for specific applications. The choice of the best steel grade for a specific application is usually based on a combination of:

- Optimum performance of the parts in service
- Industrial and economic feasibility

The graph below compares the different grades of hot rolled steel according to their strength /plasticity ratio (mechanical strength /elongation at fracture).

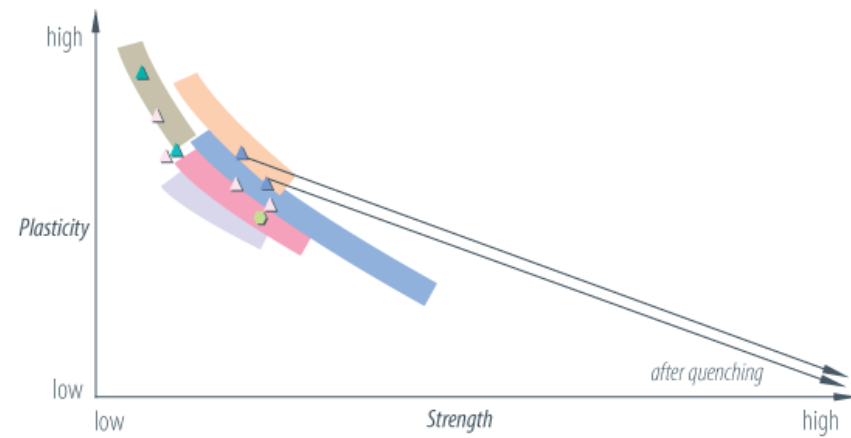

- Steels for gas containers
- Steels for pressure vessels and boilers
- Structural steels
- High or Ultra High Strength Low Alloy steels
- Steels for cold forming and deep drawing applications
- ▲ Quenchable boron steels
- △ Steels for laser cutting
- ▲ Structural forming grades
- Indaten® atmospheric corrosion resistant steels

ArcelorMittal's range

A10 Steels for cold forming and deep drawing applications

(Standard: EN 10111)

These steel grades are characterised by a low carbon content and excellent weldability.

The higher the grade number, the greater the drawability:

- DD13 AM FCE is suitable for deep drawing
- DD14 AM FCE is suitable for very deep drawing
- DD15 AM FCE is suitable for drawing particularly difficult parts requiring extreme regularity of performance especially at high production rates

A14 Structural forming grades

These steels, which are specific to the AM FCE range, are stronger than the usual forming grades.

A20-A22 High or Ultra High Strength Low Alloy steels -Armstrong™

(Standard: EN 10149-2)

These steels are low alloy, fine grain grades. They have a low carbon content and are enriched when needed with niobium, titanium and/or vanadium. Since their carbon equivalent value is low, these steels have improved weldability.

A low sulphur content, high internal purity and a fine grain structure guarantee excellent ductility, toughness and fatigue resistance.

A30 Structural steels

(Standard: EN 10025-2)

Structural steels are used primarily in mechanical engineering and building applications. They are carbon-manganese steels with a guaranteed minimum yield strength and tensile strength.

Their ductility and toughness are satisfactory. The J0, JR, J2 and K2 grades have different guaranteed toughness KV (Charpy impact strength). The addition of the suffix "+N" to the grade reference means that the properties are also guaranteed after a normalisation heat treatment. Conventional welding processes may be used.

A34 Indaten® atmospheric corrosion resistant steels

(Standard: EN 10025-5)

These steels protect themselves from corrosion by building up an aesthetically pleasing protective patina, making this a very attractive material for construction applications. These are fine grain grades with high yield strength and improved corrosion resistance in environments with a defined corrosive atmosphere. Their properties have been optimised to improve processing performance.

A40 Steels for laser cutting

This range comprises structural and low alloy steels with specially optimised properties to facilitate automatic cutting operations (typically laser cutting). They have the same mechanical properties as standard grades, plus low levels of internal stress. These properties ensure that a good standard of flatness is obtained before, during and after cutting, provided decoiling proceeds correctly. Also available in sheets with two standards of guaranteed flatness.

A54 Quenchable boron steels

(Standard: EN 10083-3)

With these steels, after quenching, it is possible to obtain very high mechanical properties whilst maintaining a relatively low carbon equivalent value to facilitate welding (see graph above).

The principal advantages are:

- Good hot formability without springback
- Exceptional fatigue strength and impact resistance, enabling a significant reduction in steel thickness, resulting in weight reduction of the finished part

A62 Steels for pressure vessels and boilers

(Standards: EN 10028-2, 3, 5 -EN 10207)

These steels differ from conventional structural steels in having high resistance to pressure at all temperatures (ambient, low or high). They have good weldability and high impact strength.

They are suitable for normalisation annealing and stress-relief annealing, which neutralises the hardening effect caused by processing. The range can be divided into four groups:

- Steels with specified mechanical properties at elevated temperatures and guaranteed performance at temperatures of up to 400°C
- Steels for simple pressure vessels
- Weldable fine grain steels, normalised, with guaranteed performance at temperatures of up to 400°C and outstanding impact strength at temperatures as low as -50°C
- Weldable fine grain steels, thermomechanically rolled, with guaranteed impact strength at temperatures as low as -40°C

A64 Steels for gas containers

(Standard: EN 10120)

ArcelorMittal can offer four grades of this type of steel, each defined according to its yield strength. These steels are suitable for deep drawing and are non-ageing.

In addition to the ranges presented above, ArcelorMittal can supply a range of hot rolled products for large welded pipes plus a variety of grades in the form of semi-finished products for which only the chemical composition is guaranteed.

A12 Steels for re-rolling

With this steel family, ArcelorMittal can supply grades ranging from DC01 to DC06, after a complete cycle of re-rolling and batch or continuous annealing.

A50 Steels with a specific chemical composition

(Standard: ASTM A568)

This range comprises a number of grades meeting the requirements of this standard, from SAE 1005 AM FCE to SAE 1018 AM FCE.

A52 High carbon steels

(Standards: EN 10183-1, EN 10132-4)

ArcelorMittal offers specific grades that meet the requirements of the above standards. These products are intended mainly for re-rolling and heat treatment and their geometry is perfectly suited for the subsequent transformation processes they will undergo. They also have excellent internal metallurgical purity. All grades in this category have a very low sulphur content. Moreover, the low aluminium content of the highest grades gives improved results when quenched. Other grades are also available in consultation, with minimum quantities per order.

A60 Steels for pipes

(Standard: API 5L)

Grades B to X80 meet the requirements of the above standard. A relatively low carbon equivalent value ensures good weldability. Special requirements, such as hydrogen-induced cracking (HIC) resistance or high ductility at low temperature, can be guaranteed.

In addition, ArcelorMittal can offer the following functional surface treatments:

A80 Steels with Easyfilm® dry coating

Easyfilm® HPE offers protection against corrosion for a period of three months, without the disadvantages of a copiously oiled product.

In order to help you choose your steel, we have compiled a comparative table (below) showing the properties and applications of ArcelorMittal's different types of steel.

Properties table

		Processing				
		Drawability	Formability	Punching ability -hole expansion	Weldability	Thermal cutting
Steels for cold forming and deep drawing applications	A10	⊕	⊕	⊕	⊕	□
Structural forming grades	A14	⊕	⊕	⊕	⊕	□
Amstrong™ - High Strength Low Alloy steels	A20	+	⊕	⊕	⊕	+
Amstrong™ - Ultra High Strength Low Alloy steels	A22	□	+	+	+	□
Structural steels	A30	□	□	□	□	□
Indaten® atmospheric corrosion resistant steels	A34	□	⊕	+	□	□
Steels for laser cutting	A40	+	⊕	⊕	⊕	⊕
Quenchable boron steels	A54	+ ¹	+ ¹	+ ¹	□	□
Steels for pipes	A60	●	+	+	⊕	+
Steels for pressure vessels and boilers	A62	□	□	□	□	□
Steels for gas containers	A64	+	+	□	⊕	□
Steels with Easyfilm® dry coating	A80	+	+	(3)	(3)	(3)

- ⊕ Excellent
- + Very good
- Good
- △ Good, but with reservations
- Not suitable

(1) Before quenching

(2) HIC corrosion

(3) Depends on the selected grade

		Properties								
		Fatigue strength	Indentation resistance	High temperature resistance	Low temperature fragility	Resistance to pressure	Abrasion resistance	Weight reduction possibility	Resistance to atmospheric corrosion	Aesthetics/the environment
Steels for cold forming and deep drawing applications	A10	●	●	●	●	●	●	●	+	□
Structural forming grades	A14	□	●	●	●	●	●	●	+	□
Armstrong™ -High Strength Low Alloy steels	A20	+	⊕	□	+	□	□	+	□	□
Armstrong™ -Ultra High Strength Low Alloy steels	A22	⊕	⊕	□	+	□	+	⊕	□	□
Structural steels	A30	□	□	□	□	□	□	□	□	□
Indaten® atmospheric corrosion resistant steels	A34	□	+	□	□	□	□	□	⊕	⊕
Steels for laser cutting	A40	+	⊕	□	+	□	□	□	□	+
Quenchable boron steels	A54	⊕	⊕	□	+	□	⊕	⊕	□	□
Steels for pipes	A60	+	+	□	⊕	+	□	+	+ ²	□
Steels for pressure vessels and boilers	A62	+	□	+	+	⊕	□	□	□	□
Steels for gas containers	A64	□	□	□	+	⊕	□	□	□	□
Steels with Easyfilm® dry coating	A80	(3)	(3)	(3)	(3)	(3)	(3)	(3)	+	+

⊕ Excellent
 + Very good
 □ Good
 △ Good, but with reservations
 ● Not suitable

(1) Before quenching

(2) HIC corrosion

(3) Depends on the selected grade

For commercial information (quotations, deliveries, product availability):

- Europe: <http://industry.arcelormittal.com/agencies>
- Other countries: contact@arcelormittal.com

For technical questions about these products: fateurope.technical.assistance@arcelormittal.com

For researchers: [click here](#)

All details provided in the ArcelorMittal Flat Carbon Europe S.A. catalogue are for information purposes only. ArcelorMittal Flat Carbon Europe S.A. reserves the right to change its product range at any time without prior notice.

A20

Amstrong™ -High Strength Low Alloy steels

A significant weight reduction can be achieved by using Armstrong™ steels.

The lighter the trailer, the heavier the payload that can be transported.

Last update: 2014-8-11



Properties

Amstrong™ steels are characterised by high ductility, controlled internal purity, fine grain structure and low carbon content.

Advantages

Amstrong™ steels combine:

- Outstanding mechanical properties
 - High strength
 - Toughness
 - Fatigue resistance
- Good formability, and
- Good weldability

With their high strength, they are an excellent choice when weight-saving is a priority, and are frequently used to replace structural steels.

Applications

High strength Armstrong™ steels are used in a wide range of applications in transport (earth movers, trailers, agricultural and railroad machinery etc), profiling (racks etc) and building (cranes, safety barriers, light poles etc). Significant weight reductions can be achieved by using Armstrong™ steels, especially for cranes and heavy vehicle trailers, thus allowing a larger payload.

Brand correspondence

	EN 10149-2:2013	SEW 092:1990	UNE 36090	NF A 36-231:1992	BS 1449/1	ASTM A1011-12	Old brand names
Amstrong™ 240MC							
Amstrong™ 280MC		<i>QstE300TM</i>	<i>AE275HC</i>		<i>HR40 F30</i>		<i>Soldur 280/Profilar 300/BSK 30</i>
S315MC EN 10149-2	S315MC						
Amstrong™ 315MC	S315MC	<i>QstE340TM</i>		E315D		HSLAS-F Grade 45 class 2	Soldur 320/Profilar 340/BSK 34/SPXE 340
S355MC EN 10149-2	S355MC						
Amstrong™ 355MC	S355MC	<i>QstE380TM</i>	<i>AE340HC</i>	E355D	<i>HR43 F35</i>	HSLAS-F Grade 50 class 2	Soldur 360/Profilar 380/BSK 38/SPXE 380
Amstrong™ 390MC		<i>QstE420TM</i>	<i>AE390HC</i>		<i>HR46 F40</i>		<i>Profilar 420/BSK 42/SPXE 420</i>
S420MC EN 10149-2	S420MC						
Amstrong™ 420MC	S420MC	<i>QstE460TM</i>	<i>AE440HC</i>	E420D	<i>HR50 F45</i>	HSLAS-F Grade 60 class 2	Soldur 420/Profilar 460/BSK 46
S460MC EN 10149-2	S460MC						
Amstrong™ 460MC	S460MC	<i>QstE500TM</i>	<i>AE490HC</i>			HSLAS-F Grade 65 class 2	Soldur 460/Profilar 500/BSK 50/SPXE 480
S500MC EN 10149-2	S500MC						
Amstrong™ 500MC	S500MC	<i>QstE550TM</i>		E490D		HSLAS-F Grade 70 class 2	Soldur 500/Profilar 550/BSK 55/SPXE 530
S550MC EN 10149-2	S550MC						
Amstrong™ 550MC	S550MC	<i>(QstE600TM)</i>		E560D	<i>HR60 F55</i>	HSLAS-F Grade 80 class 2	Soldur 550
S600MC EN 10149-2	S600MC	<i>(QstE650TM)</i>					
Amstrong™ 600MC	S600MC	<i>(QstE650TM)</i>					

Grades in italics: not included in the standard

(j) Closest grade as no fully equivalent grade exists.

Dimensions

Mill finish

Thickness (mm)	Min width	Amstrong™ 240MC	Amstrong™ 280MC	S315MC EN 10149-2, Amstrong™ 315MC	S355MC EN 10149-2, Amstrong™ 355MC	Amstrong™ 390MC	S420MC EN 10149-2, Amstrong™ 420MC	S460MC EN 10149-2, Amstrong™ 460MC	S500MC EN 10149-2, Amstrong™ 500MC	S550MC EN 10149-2, Amstrong™ 550MC	S600MC EN 10149-2, Amstrong™ 600MC			
		Max width	Max width	Max width	Max width	Max width	Max width	Max width	Max width	Max width	Max width			
1.50 ≤ th < 1.60	800	1540	1350	1300	1180	-	-	-	-	-	-			
1.60 ≤ th < 1.70						-	-	-	-	-	-			
1.70 ≤ th < 1.80						1020	-	-	-	-				
1.80 ≤ th < 1.90		1200	1450	1450	1300	1200	1020	1200	1050	-	-			
1.90 ≤ th < 2.00		1250	1500	1540	1400	1250	1250	1250	1120	940	-			
2.00 ≤ th < 2.20		1350	1600	1600	1450	1350	1350	1350	1280	1200	1100			
2.20 ≤ th < 2.40			1680		1470	1400			1320		1170			
2.40 ≤ th < 2.50		1400	1930	1800	1680	1550	1400	1400	1380	1350	1200			
2.50 ≤ th < 2.60		1450	1850	1740	1700				1450	1450	1420	1380	1250	
2.60 ≤ th < 2.80		1530	1880	1820	1700	1450	1450	1450	1460	1410	1340			
2.80 ≤ th < 3.00									1520	1510		1520	1470	
3.00 ≤ th < 3.30		1600	2030	2000	1790	1600	1650	1650	1570	1530				
3.30 ≤ th < 3.50		1650	2130	2030	1820	1650	1700	1700	1650	1630				
3.50 ≤ th < 4.00									1750	1780	1780	1740	1740	1440
4.00 ≤ th < 4.50									2040	2040	2040	2020	2020	2020
4.50 ≤ th < 5.50		1650	2040	2130	1820	1650	1700	1700	1650	1630	1630			
5.50 ≤ th < 6.00											1830			
6.00 ≤ th < 6.50	2135													
6.50 ≤ th < 8.50	1650	1790	2030	2130	1650	1700	1700	1650	1630	2150				
8.50 ≤ th < 9.50										2150	2150	2150	2150	2150
9.50 ≤ th < 10.00	1650	1570	1700	1570	1650	1700	1700	1650	1630	2050				
10.00 ≤ th < 12.00										1980				
12.00 ≤ th < 13.00										1930				
13.00 ≤ th < 14.00	1650	1370	1370	2050	1650	1700	1700	1650	1630	-				
14.00 ≤ th < 15.00										-				
15.00 ≤ th < 16.00	1370	1370	2050	-	1370	2050	2050	-	-	-				

Pickled

Thickness (mm)	Min width	Amstrong™ 240MC	Amstrong™ 280MC	S315MC EN 10149-2, Amstrong™ 315MC	S355MC EN 10149-2, Amstrong™ 355MC	Amstrong™ 390MC	S420MC EN 10149-2, Amstrong™ 420MC	S460MC EN 10149-2	Amstrong™ 460MC	S500MC EN 10149-2, Amstrong™ 500MC	S550MC EN 10149-2	Amstrong™ 550MC	S600MC EN 10149-2, Amstrong™ 600MC				
		Max width	Max width	Max width	Max width	Max width	Max width	Max width	Max width	Max width	Max width	Max width	Max width				
1.50 ≤ th < 1.60	800	1540	1320	1140	1090	-	-	-	-	-	-	-	-				
1.60 ≤ th < 1.70			1350	1190	1160												
1.70 ≤ th < 1.80		1590	1420	1270	1230	1020	-	-	-	-	-	-	-				
1.80 ≤ th < 1.90		1630	1450	1320	1300	1100								1020			
1.90 ≤ th < 2.00		1780	1500	1540	1330	1180	1120	1050	1050	1120	940	940	-				
2.00 ≤ th < 2.10		1830	1600		1450	1350	1350	1350	1350	1350	1280	1230		1230	1100		
2.10 ≤ th < 2.20			1620								1310	1260		1260			
2.20 ≤ th < 2.30			1680								1340	1290		1290		1170	
2.30 ≤ th < 2.40		1930	1740	1525	1400	1400	1400	1400	1370	1320	1320						
2.40 ≤ th < 2.50			1800	1560	1540	1450	1450	1450	1450	1400	1350	1350	1200				
2.50 ≤ th < 2.60		1980	1850	1560	1450					1450	1450	1450	1430	1380	1380	1250	
2.60 ≤ th < 2.70			2030	1880	1730	1580	1470	1450	1450				1460	1410	1410	1340	
2.70 ≤ th < 2.80		1600				1500	1480	1490	1440	1440							
2.80 ≤ th < 2.90		1630				1530	1520	1510	1510	1520	1470	1470					
2.90 ≤ th < 3.00		1650				1560	1540	1540	1540	1550	1500	1500					
3.00 ≤ th < 3.10		2030	1880	1730	1580	1580	1580	1580	1580	1580	1530	1530	1340				
3.10 ≤ th < 3.20					1620	1620	1620	1620	1600	1560	1560						
3.20 ≤ th < 3.30		2130	1840	1880	1730	1660	1660	1660	1660	1620	1590	1590	1440				
3.30 ≤ th < 3.40											1740	1720		1720	1720	1720	1630
3.40 ≤ th < 3.50										1740		1740		1740	1740	1740	1680
3.50 ≤ th < 3.60	2130										1840	1880		1780	1780	1780	1780
3.60 ≤ th < 3.70		1880	1820	1820	1820	1820	1800	1800	1800								
3.70 ≤ th < 3.80			1860	1860	1860	1860	1860	1850	1850	1850							
3.80 ≤ th < 3.90		1920		1920	1920	1920	1920	1900	1900	1900							
3.90 ≤ th < 4.00	2130	1840	1880	1920	1980	1980	1980	1980	1950	1950	1950	1340					
4.00 ≤ th < 4.10									2040	2040	2040		2020	2020	2020	2020	2020
4.10 ≤ th < 5.00									2070	2070	2070		2070	2070	2070	2070	2070
5.00 ≤ th < 6.00									2130	2130	2130						
6.00 ≤ th < 6.10	1600	2130	2070	2070	2070	2070	2070	2070									
6.10 ≤ th < 6.30									1520	1700	1700	1525	1525	1525	1525	1525	
6.30 ≤ th < 7.00	1525	1550	1550	1525	1525	1525	1525	1525									
7.00 ≤ th < 7.10									1525	1550	1550	1525	1525	1525	1525	1525	
7.10 ≤ th < 8.00	1525	1550	1550	1525	1525	1525	1525	1525									

8.00 ≤ th < 8.10		1525		1525	1525	1525						
8.10 ≤ th < 10.00			1525	1525								-
10.00 ≤ th < 12.00	*	*					*	*	*	*		-
12.00 ≤ th < 13.00			*	*	*	*					*	*

* Pickled products with thicknesses up to 15 mm may be delivered after prior agreement: please contact us.

Mechanical properties

	Direction	Thickness (mm)	R _o (MPa)	R _m (MPa)	A ₈₀ (%)	A 5.65√S _o (%)	Bending ratio (th)	KV -20°C (J)
Armstrong™ 240MC	L	< 3	240 -320	340 -450	≥ 27	-	-	-
		3 -6			-	≥ 32		≥ 40
		6 -16						
	T	< 3	260 -340	340 -450	≥ 26	-	0	-
		3 -16			-	≥ 31		-
Armstrong™ 280MC	L	< 3	280 -350	370 -450	≥ 26	-	-	-
		3 -6			-	≥ 30		≥ 40
		6 -16						
	T	< 3	300 -380	370 -450	≥ 25	-	0	-
		3 -16			-	≥ 29		-
S315MC EN 10149-2	L	1.5 -3	≥ 315	390 -510	≥ 20	-	-	-
		3 -20			-	≥ 24		-
	T	1.5 -20	-	-	-	-	0	-
Armstrong™ 315MC	L	< 3	315 -395	415 - 495	≥ 24	-	-	-
		3 -6			-	≥ 28		≥ 40
		6 -16						
	T	< 3	340 - 420	420 - 500	≥ 23	-	0	-
		3 -16			-	≥ 27		-
S355MC EN 10149-2	L	1.5 -3	≥ 355	430 -550	≥ 19	-	-	-
		3 -20			-	≥ 23		-
	T	1.5 -20	-	-	-	-	≥ 0.5	-
Armstrong™ 355MC	L	< 3	355 -435	430 -520	≥ 22	-	-	-
		3 -6			-	≥ 25		≥ 40
		6 -16						
	T	< 3	380 - 460	440 - 530	≥ 21	-	0	-
		3 -16			-	≥ 24		-
Armstrong™ 390MC	L	< 3	390 -480	460 -560	≥ 20	-	-	-
		3 -6			-	≥ 24		≥ 40
		6 -16						
	T	< 3	420 -500	470 -570	≥ 19	-	0	-
		3 -16			-	≥ 23		-
S420MC EN 10149-2	L	1.5 -3	≥ 420	480 -620	≥ 16	-	-	-
		3 -20			-	≥ 19		-
	T	1.5 -20	-	-	-	-	≥ 0.5	-
Armstrong™ 420MC	L	< 3	420 -520	490 - 600	≥ 18	-	-	-
		3 -6			-	≥ 22		≥ 40
		6 -16						
	T	< 3	450 - 550	500 - 600	≥ 17	-	≥ 0.2	-
		3 -13			-	≥ 21		-
		13 -16						≥ 0.5
S460MC EN 10149-2	L	1.5 -3	≥ 460	520 -670	≥ 14	-	-	-
		3 -20			-	≥ 17		-
	T	1.5 -20	-	-	-	-	≥ 1	-
Armstrong™ 460MC	L	< 3	460 -560	520 -640	≥ 15	-	-	-
		3 -6			-	≥ 18		≥ 40
		6 -16						
		< 3			≥ 14	-	> 0.6	

	T	3-6	490 - 590	530 - 640	-	≥ 17	≥ 1	-
		6-16						
S500MC EN 10149-2	L	1.5-3	≥ 500	550-700	≥ 12	-	-	-
		3-16			-	≥ 14		
		16-20			-	-		
T	1.5-16	-	-	-	-	≥ 1	-	
Amstrong™ 500MC	L	< 2	500 - 600	560 - 700	≥ 15	-	-	-
		2-3			≥ 16			
		3-6			-	≥ 19		
		6-16			-	-		
T	< 2	530 - 630	570 - 700	≥ 14	-	≥ 0.6	-	
	2-3			≥ 15				
	3-6			-	≥ 18			
	6-16			-	-			
S550MC EN 10149-2	L	1.5-3	≥ 550	600-760	≥ 12	-	-	-
		3-16			-	≥ 14		
		16-20			-	-		
T	1.5-16	-	-	-	-	≥ 1.5	-	
Amstrong™ 550MC	L	< 3	550 - 650	620 - 750	≥ 12	-	-	-
		3-6			-	≥ 14		
		6-16			-	-		
	≥ 40							
T	< 3	580 - 680	630 - 750	≥ 11	-	≥ 0.8	-	
	3-6			-	≥ 13			
	6-16			-	-			
≥ 1.5								
S600MC EN 10149-2	L	2-3	≥ 600	650-820	≥ 11	-	-	-
		3-10			-	≥ 13		
T	2-10	-	-	-	-	≥ 1.5	-	
Amstrong™ 600MC	L	2-3	≥ 600	650-820	≥ 11	-	-	-
		3-6			-	≥ 13		
		6-10			-	-		
	≥ 40							
T	2-3	≥ 620	660 - 820	≥ 10	-	≥ 1.5	-	
	3-10			-	≥ 12			

Grades in italics: not included in the standard

Values in bold: tighter than the standard

For Armstrong™ grades, the mechanical properties are guaranteed in both directions.

Toughness guarantee at -40°C: on request

Chemical composition

	C (%)	Mn (%)	P (%)	S (%)	Si (%)	Al (%)	Mo (%)	Nb (%)	V (%)	Ti (%)	B (%)	C _{eq} (%)	Galvanisation
<i>Amstrong™ 240MC</i>	≤ 0.100	≤ 0.80	≤ 0.020	≤ 0.020	≤ 0.03	≥ 0.015	-	≤ 0.025	≤ 0.200	≤ 0.150	-	≤ 0.18	Class 1
<i>Amstrong™ 280MC</i>	≤ 0.080	≤ 0.80	≤ 0.020	≤ 0.015	≤ 0.03	≥ 0.015	-	≤ 0.025	≤ 0.200	≤ 0.150	-	≤ 0.23	Class 1
S315MC EN 10149-2	≤ 0.120	≤ 1.30	≤ 0.025	≤ 0.020	≤ 0.50	≥ 0.015	-	≤ 0.090	≤ 0.200	≤ 0.150	-	-	No
<i>Amstrong™ 315MC</i>	≤ 0.100	≤ 0.70	≤ 0.020	≤ 0.015	≤ 0.03	≥ 0.015	-	≤ 0.045	≤ 0.200	≤ 0.150	-	≤ 0.25	Class 1
S355MC EN 10149-2	≤ 0.120	≤ 1.50	≤ 0.025	≤ 0.020	≤ 0.50	≥ 0.015	-	≤ 0.090	≤ 0.200	≤ 0.150	-	-	No
<i>Amstrong™ 355MC</i>	≤ 0.100	≤ 1.40	≤ 0.020	≤ 0.015	≤ 0.03	≥ 0.015	-	≤ 0.065	≤ 0.200	≤ 0.150	-	≤ 0.32	Class 1
<i>Amstrong™ 390MC</i>	≤ 0.100	≤ 1.50	≤ 0.020	≤ 0.012	≤ 0.03	≥ 0.015	-	≤ 0.065	≤ 0.200	≤ 0.150	-	≤ 0.36	Class 1
S420MC EN 10149-2	≤ 0.120	≤ 1.60	≤ 0.025	≤ 0.015	≤ 0.50	≥ 0.015	-	≤ 0.090	≤ 0.200	≤ 0.150	-	-	No
<i>Amstrong™ 420MC</i>	≤ 0.110	≤ 1.50	≤ 0.020	≤ 0.012	≤ 0.03	≥ 0.015	-	≤ 0.065	≤ 0.200	≤ 0.150	-	≤ 0.38	Class 1
S460MC EN 10149-2	≤ 0.120	≤ 1.60	≤ 0.025	≤ 0.015	≤ 0.50	≥ 0.015	-	≤ 0.090	≤ 0.200	≤ 0.150	-	-	No
<i>Amstrong™ 460MC</i>	≤ 0.120	≤ 1.50	≤ 0.020	≤ 0.012	≤ 0.03	≥ 0.015	-	≤ 0.080	≤ 0.200	≤ 0.150	-	≤ 0.40	Class 1
S500MC EN 10149-2	≤ 0.120	≤ 1.70	≤ 0.025	≤ 0.015	≤ 0.50	≥ 0.015	-	≤ 0.090	≤ 0.200	≤ 0.150	-	-	No
<i>Amstrong™ 500MC</i>	≤ 0.120	≤ 1.70	≤ 0.020	≤ 0.012	≤ 0.03	≥ 0.015	-	≤ 0.090	≤ 0.200	≤ 0.150	-	≤ 0.42	Class 1
S550MC EN 10149-2	≤ 0.120	≤ 1.80	≤ 0.025	≤ 0.015	≤ 0.50	≥ 0.015	-	≤ 0.090	≤ 0.200	≤ 0.150	-	-	No
<i>Amstrong™ 550MC</i>	≤ 0.100	≤ 1.70	≤ 0.020	≤ 0.012	≤ 0.03	≥ 0.015	-	≤ 0.090	≤ 0.200	≤ 0.150	-	≤ 0.44	Class 1
S600MC EN 10149-2	≤ 0.120	≤ 1.90	≤ 0.025	≤ 0.015	≤ 0.50	≥ 0.015	≤ 0.50	≤ 0.090	≤ 0.200	≤ 0.220	≤ 0.0050	-	No
<i>Amstrong™ 600MC</i>	≤ 0.120	≤ 1.90	≤ 0.020	≤ 0.015	≤ 0.03	≥ 0.015	≤ 0.50	≤ 0.090	≤ 0.200	≤ 0.220	≤ 0.0050	≤ 0.44	Class 1

Grades in italics: not included in the standard

Values in bold: tighter than the standard

The chemical properties given are based on cast analysis data.

V +Nb +Ti ≤ 0.22%.

Suitability for hot-dip zinc coating is defined as per the requirements of EN ISO 14713-2 Table 1 and NFA 35-503.

For commercial information (quotations, deliveries, product availability):

- Europe: <http://industry.arcelormittal.com/agencies>
- Other countries: contact@arcelormittal.com

For technical questions about these products: flateurope.technical.assistance@arcelormittal.com

For researchers: [click here](#)

All details provided in the ArcelorMittal Flat Carbon Europe S.A. catalogue are for information purposes only. ArcelorMittal Flat Carbon Europe S.A. reserves the right to change its product range at any time without prior notice.



A22

Amstrong™ -Ultra High Strength Low Alloy steels

Using these steel grades makes it possible to build longer/higher booms for cranes and aerial platforms.

Last update: 2014-4-28



Properties

These low alloy steel grades complete the Armstrong™ range of HSLA grades (see data sheet A20) and offer exceptionally high yield strength values. They have a fine grain structure, low carbon content for improved weldability, and controlled internal purity.

Advantages

Weight reduction

The grades in this data sheet combine outstanding mechanical properties (very high strength, fatigue resistance and toughness) with good formability and weldability. Their guaranteed high yield strength makes it possible to achieve substantial weight reduction through thickness reduction, whilst maintaining overall performance and safety. These steel grades are therefore frequently used to replace structural steel grades when weight reduction is required.

Thickness reduction brings additional savings when processing the material, since it is easier to weld, and reduces transport costs. Further savings are also achieved in service, in the form of lower energy consumption, improved mechanical performance, safety etc.

Abrasion/wear resistance

In some applications (conveying devices, earth-moving or transportation vehicles etc), wear can result from the action of abrasive substances on the steel surface. This is a complex physical phenomenon, which depends not only on the abrasive material itself, but also on the way abrasion occurs (pressure, load, impact etc).

Compared with standard structural steel grades, Ultra High Strength Low Alloy steel grades allow a significant improvement in wear resistance. In many cases, they can be more economical and easier to process than steel grades specifically designed for wear resistance.

Applications

Their very high yield strength contributes to a solution that increases the payload capacity and gives higher strength structures.

Typical applications include telescopic cranes, aerial platforms, concrete pumps, telescopic handlers, tippers and truck trailers, where the emphasis is on strength and weight reduction potential.

Recommendations for use

Laser cutting

These grades are suitable for oxygen, plasma and laser cutting.

Estimation of the possible thickness reduction

When switching from grade 1 (with low yield strength) to grade 2 (proposed in this data sheet), an estimation of the thickness reduction that can be achieved is given by the following formula:

$$t_2 = t_1 \left(\frac{R_{e1}}{R_{e2}} \right)^{0.5}$$

where t = thickness R_e = yield strength

Please note that other issues, such as fatigue resistance, need to be checked before reducing thickness.

Surface quality

These grades are available in "A -Unexposed" finish only.

Weldability

Weldability and cold crack susceptibility of these grades are more accurately assessed using the PCM formula (parameter crack measurement), which was developed for low carbon steels (< 0.11%).

Due to their low carbon equivalent value (PCM < 0.25), these ArcelorMittal grades do not need to be pre-or post-heated when welding. They are not prone to excessive hardening due to their low carbon and low alloy content, are totally insensitive to cold cracking and are suitable for all types of arc welding.

	Thickness range	CEV typical	PCM typical
Amstrong™ 650MC	≤ 12 mm	0.42	0.18
	> 12 mm	0.45	
Amstrong™ 700MC	< 6 mm	0.37	0.16
	6 < 10 mm	0.43	0.18
	≥ 10 mm	0.45	

$$CEV = C + \frac{Mn}{6} + \frac{Cr + Mo + V}{5} + \frac{Ni + Cu}{15}$$

$$PCM = C + \frac{Si}{30} + \frac{Mn + Cu + Cr}{20} + \frac{Ni}{60} + \frac{Mo}{15} + \frac{V}{10} + 5B$$

Heat-affected zone softening -welding recommendations

If special care is not taken, softening may occur in the heat-affected zone (HAZ), particularly in the intercritical heat-affected zone (ICHAZ), which is typical behaviour of thermomechanically rolled steel grades with yield strength above 500 MPa. The extent of softening and the width of the softened zone increases with heat input applied during welding.

In order to preserve the high mechanical properties of the base material after welding, the recommendation is to limit the welding energy to about 1.5 kJ/cm per millimetre of thickness, as shown in the figure below, which corresponds to the following maximum cooling times (between 800°C and 500°C):

- When only the joint strength is a priority, we recommend using heat inputs that make it possible to reach t800 ≤ 20 s
- When both the joint strength and the toughness of the HAZ (at -40°C) are priorities, we recommend using lower heat inputs that make it possible to reach t800 ≤ 13 s

MAG Welding - Armstrong™ 700MC

Linear heat input (kJ/cm)

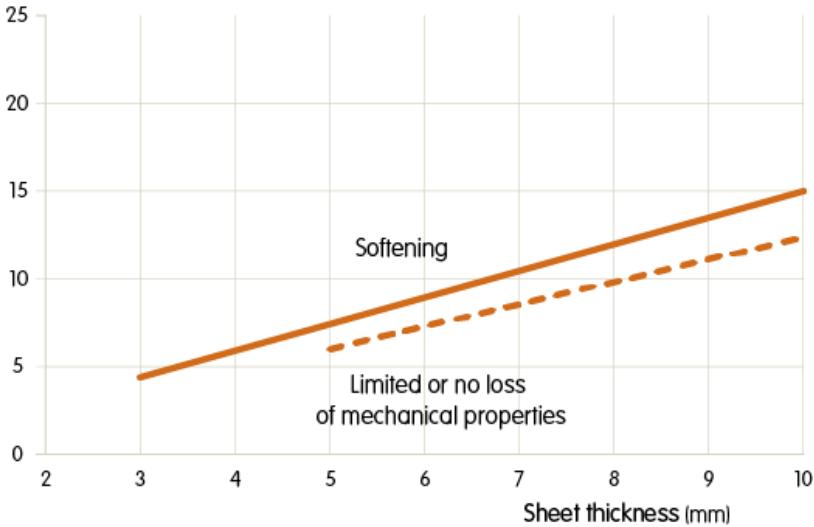

Recommendations for selecting the suitable heat input for MAG welding of Armstrong™ 700MC grade.

Interpass temperature & heat treatment

Amstrong™ 650MC and Armstrong™ 700MC do not need to be pre-or post-heated when welding. In multi-pass welding, interpass temperature acts as preheating for the subsequent pass and increases cooling time. The interpass temperature should therefore be limited to minimise any loss in mechanical properties. The maximum recommended interpass temperature is 100°C.

Similarly, post-weld heat treatment may cause loss in mechanical properties. We therefore strongly recommend that you contact ArcelorMittal prior to performing any heat treatment, to define the suitable settings.

Filler wire selection

We recommend using filler wires that at least match or overmatch the strength of the base material. Recommended wires/fluxes for Armstrong™ 700MC are listed in the table below.

Supplier	SMAW	GMAW	FCAW	SAW	
Esab	OK 75.75	OK Autrod 13.29, OK Aristorod 13.31	OK Tubrod 14.03	OK Autrod 13.43	OK Flux 10.62
Filarc	Filarc 118		Filarc PZ 6148		
Lincoln	Conarc 80	LNM MoNiVa	Outershield 690-H	LNS 168	P230
	Conarc 85		Outershield MC-100	LA 100	Lincolnweld 8500
Oerlikon	Tenacito 80 CL	Carbofil NiMoCr	Fluxofil 42	OE-S3 NiMoCr	OP 121TT
	Tenax 118M	Carbofil MnNiMo	Citoflux M07	Fluxocord 42	
S.A.F. Air Liquide	Safer ND 80	Nertalic 88	Steelcored 42		
			Safdual 270		
Thyssen	SHNK 100	Union NiMoCr		Union S3 NiMoCr	UV 421TT

Mechanical properties after welding

When welded within the recommended heat input range, the tensile strength and the impact toughness of the welded area of Armstrong™ 650MC and Armstrong™ 700MC steel grades are superior to the minimum requirements of European standards EN 288 and EN 10149 relating to the base metal.

Fatigue resistance

The fine grain size and low sulphur content improve the fatigue resistance of the steel. Fatigue performance is measured by uniaxial tests at different stress levels. These values are used to plot the Wöhler curve and determine the endurance limit of the steel grade.

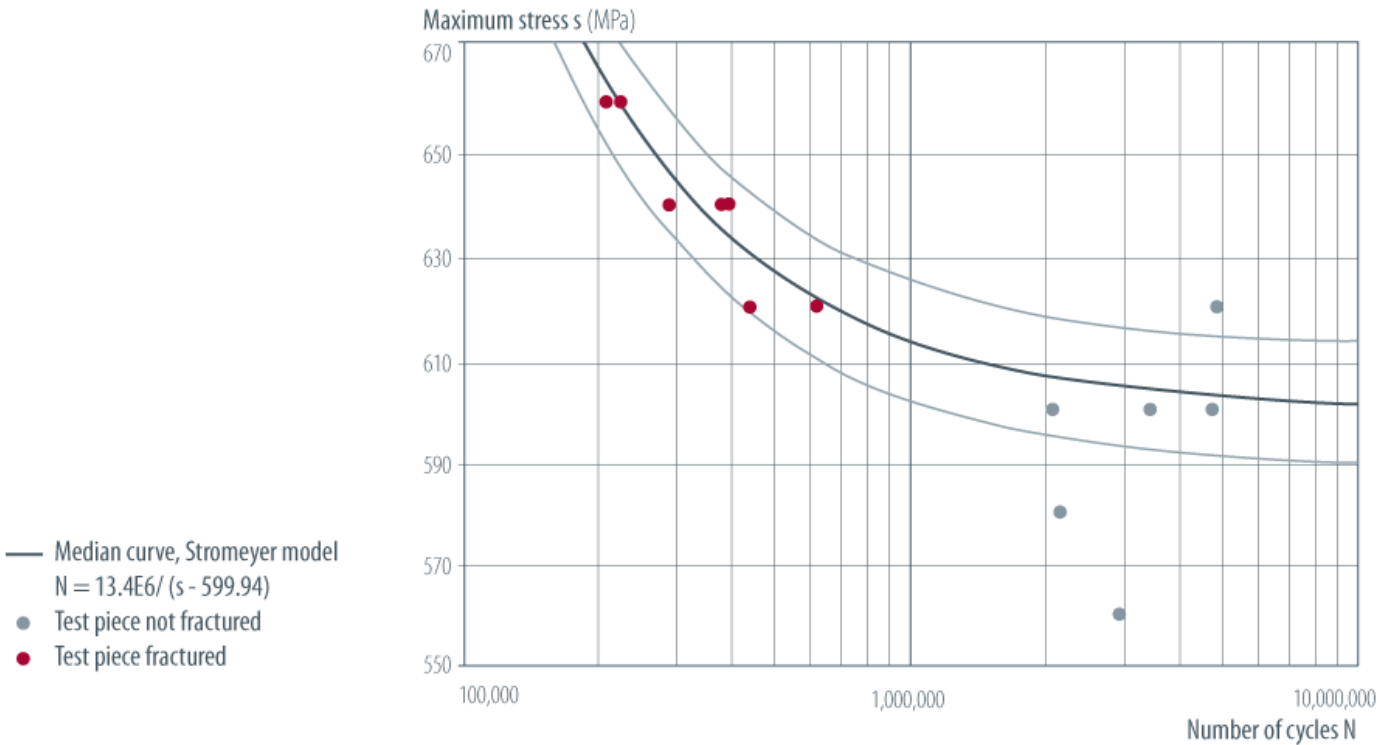

Typical Wöhler curves of Armstrong™ 700MC show an endurance limit above 560 MPa (with $R = 0.1$).

However, it should be noted that it is advisable -as with most materials -to keep welds away from highly stressed zones, particularly in the case of dynamic loading, since the Wöhler curve for welds depends on welding conditions.

Brand correspondence

	EN 10149-2:2013	NF A 36-203:1992	BS 1449/1	SEW 92*	USA ASTM
S650MC EN 10149-2	S650MC			(QstE 690TM)	
Amstrong™ 650MC					
S700MC EN 10149-2	S700MC	(E690D)			
Amstrong™ 700MC	S700MC	(E690D)	75F70		A514
<i>() Closest grade as no fully equivalent grade exists.</i>					
<i>* The values for the tensile test of these steel grades apply to transverse test pieces.</i>					

Dimensions

Mill finish

Thickness (mm)	Min width	S650MC EN 10149-2, Armstrong™ 650MC	S700MC EN 10149-2, Armstrong™ 700MC
		Max width	Max width
2.00 ≤ th < 2.80	800	-	*
2.80 ≤ th < 2.90		1300	1300
2.90 ≤ th < 3.00		1400	1400
3.00 ≤ th < 4.00		1520	1520
4.00 ≤ th < 5.00		1620	1620
5.00 ≤ th < 6.00		1720	1720
6.00 ≤ th < 7.00		1770	1770
7.00 ≤ th < 8.00		1820	1837
8.00 ≤ th < 9.00			
9.00 ≤ th < 10.00			*
10.00 ≤ th < 12.00		*	
12.00 ≤ th < 13.00			
13.00 ≤ th < 15.00			-

* Please contact us.

Pickled

Available on request. Please contact us.

Mechanical properties

Toughness

The fine grain size and low sulphur and carbon content of these Armstrong™ grades improve steel toughness.

For this reason, the option proposed by EN 10149:2013 for this characteristic is included in our Armstrong™ range.

Two versions of Armstrong™ 650MC and Armstrong™ 700MC are available:

- Standard version with a toughness guarantee of 40J/-20°C.
- Tough version with a toughness guarantee of 27J/-40°C.

Bending

The minimum 180° bending radius of Armstrong™ 650MC and Armstrong™ 700MC can vary according to the edge quality of the sheet:

- On milled edges and good-quality plasma or laser cut edges, bending can be performed with a minimum mandrel diameter of 1.8 times the sheet thickness
- For cut edges (sheared or slit), depending on the care exercised in shearing/cutting, a bend with a mandrel diameter of 1.8 times the thickness can be achieved, but fracture of the outside surface of the bend edge may occur



	Notes	Direction	Thickness (mm)	R _e (MPa)	R _m (MPa)	A ₈₀ (%)	A 5.65√S ₀ (%)	Bending ratio (th)	KV -20°C (J)	KV -40°C (J)	
S650MC EN 10149-2		L	2-3	≥ 650	700-880	≥ 10	-	-	-	-	
			3-8			-	≥ 12				
			8-10	≥ 630		-	-				
		T	2-10	-	-	-	-	2-0	-	-	
Amstrong™ 650MC	1	L	2-3	≥ 650	700-850	≥ 10	-	-	-	-	
			3-6			-	≥ 14				
			6-8	-		-	≥ 40				≥ 27
			8-15	≥ 630		-	-				
		T	2-3	≥ 670	710-880	≥ 10	-	≥ 1.8	-	-	
			3-8			-	≥ 12				
8-15	≥ 650		-	-							
S700MC EN 10149-2		L	2-3	≥ 700	750-950	≥ 10	-	-	-	-	
			3-8			-	≥ 12				
			8-10	≥ 680		-	-				
		T	2-10	-	-	-	-	≥ 2	-	-	
Amstrong™ 700MC	1	L	2-3	≥ 700	750-930	≥ 10	-	-	-	-	
			3-6			-	≥ 14				
			6-8	-		-	≥ 40				≥ 27
			8-13	≥ 680		-	-				
		T	2-3	≥ 720	760-950	≥ 10	-	≥ 1.8	-	-	
			3-8			-	≥ 12				
			8-10	≥ 700		-	-				
			10-13	≥ 700		-	-				

Values in bold: tighter than the standard

1. Tough version with a toughness guarantee of 27J/-40°C, symbolised in the steel grade name by the T -Amstrong™ 650MCT and Amstrong™ 700MCT.

Chemical composition

	C (%)	Mn (%)	P (%)	S (%)	Si (%)	Al (%)	Mo (%)	Nb (%)	V (%)	Ti (%)	B (%)	Galvanisation
S650MC EN 10149-2	≤ 0.120	≤ 2.00	≤ 0.025	≤ 0.015	≤ 0.60	≥ 0.015	≤ 0.50	≤ 0.090	≤ 0.200	≤ 0.220	≤ 0.0050	No
Amstrong™ 650MC	≤ 0.100	≤ 2.00	≤ 0.025	≤ 0.005	≤ 0.25	≥ 0.015	≤ 0.50	≤ 0.090	≤ 0.200	≤ 0.150	≤ 0.0050	-
S700MC EN 10149-2	≤ 0.120	≤ 2.10	≤ 0.025	≤ 0.015	≤ 0.60	≥ 0.015	≤ 0.50	≤ 0.090	≤ 0.200	≤ 0.220	≤ 0.0050	No
Amstrong™ 700MC	≤ 0.100	≤ 2.10	≤ 0.025	≤ 0.005	≤ 0.25	≥ 0.015	≤ 0.50	≤ 0.090	≤ 0.200	≤ 0.150	≤ 0.0050	-

Values in bold: tighter than the standard

The above chemical properties are based on cast analysis data.

The total Nb, V and Ti content should not exceed 0.22%.

Galvanisability is defined as per the requirements of EN ISO 14713-2 Table 1.

Amstrong™ 650MC and Amstrong™ 700MC: Cat. A possible on request for thicknesses ≤ 8 mm and Cat. B available for higher thicknesses.

For commercial information (quotations, deliveries, product availability):

- Europe: <http://industry.arcelormittal.com/agencies>
- Other countries: contact@arcelormittal.com

For technical questions about these products: fateurope.technical.assistance@arcelormittal.com

For researchers: [click here](#)

All details provided in the ArcelorMittal Flat Carbon Europe S.A. catalogue are for information purposes only. ArcelorMittal Flat Carbon Europe S.A. reserves the right to change its product range at any time without prior notice.



A30

Structural steels

Structural steels can be used in the building industry, for example for light steel-frame construction.

Last update: 2014-8-7



Properties

Structural steels are carbon-manganese steels with a guaranteed minimum yield strength and tensile strength, and satisfactory ductility. These steels are suitable for most common applications and are readily available from distributors and Steel Service Centres in the most common forms and dimensions.

Various grades can be supplied:

- Without any special rolling and/or heat treatment requirements. The abbreviated designation of this delivery condition is +AR.
- Following a rolling process in which final forming is carried out within a certain temperature range, producing a material in a condition equivalent to that obtained after normalisation, with the result that the specified mechanical properties values are conserved even after normalisation treatment. The abbreviated designation of this delivery condition is +N.

Advantages

Structural steels offer good weldability with conventional welding processes. In most cases, pre-or post-heat treatment is not necessary with welding. In addition to their good mechanical properties, structural steels also have very acceptable toughness values.

Applications

Structural steels are mainly used in the building industry and in mechanical engineering. Applications include building components, containers, storage tanks and roll formed profiles.

Since 1 July 2013, the Construction Products Regulation (Regulation (EU) No. 305/2011 – CPR) has required that CE marking be affixed to all products delivered in accordance with a harmonised standard (e.g. EN 10025). This CE marking guarantees, for the uses defined in the standard, the properties described in the declaration of performance submitted by the manufacturer.

All of the steels in this data sheet comply with this Regulation.

The corresponding declarations of performance are available on our website at:

<http://dop.arcelormittal.net/index.php>

Recommendations for use

Options available (after prior agreement):

- Suitability for galvanising: + CL1 or + CL3
- Suitability for cold forming: + C
- Copper addition: + Cu

Brand correspondence

	EN 10025-2:2004	DIN 17100:1983	UNE 36080:1990	EN 10025-2:1993	NF A 35-501	PN-88/ H-84020:1988	PN-86/ H-84018:1986	ZN-96/0632-07:1996	CSN	UN 7070	BS 4360:1996	SS
S185 EN 10025-2	S185	St33	A310-0	S185	A33					Fe 320		13 00-00
S235JR EN 10025-2	S235JR	RSt37-2	AE235 B	S235JRG2	(E24-2)	St3S				(Fe 360 B)	40 B	13 12-00
<i>S235JR-CL1 AM FCE</i>	<i>(S235JR- Galva1)</i>	<i>(RSt37-2)</i>	<i>(AE235 B)</i>	<i>(S235JRG2)</i>	<i>(E24-2)</i>	<i>St3S</i>			11375	<i>(Fe 360 B)</i>	<i>(40 B)</i>	<i>(13 12-00)</i>
S235J0 EN 10025-2	S235J0	St37-3 U	AE235 C	S235J0	E24-3					Fe 360 C	40 C	
S235J0 AM FCE	S235J0	St37-3 U	AE235 C	S235J0	E24-3	(St3V)			11378	Fe 360 C	40 C	
S235J2 EN 10025-2	S235J2			S235J2G4								
S235J2 AM FCE	S235J2			S235J2G4			St3SAL		11378		40 D	
S235J2+N EN 10025-2	S235J2+N	St37-3 N	AE235 D	S235J2G3	E24-4				11378	Fe 360D		
S235J2+N AM FCE	S235J2+N	St37-3 N	AE235 D	S235J2G3	E24-4	(St3W)			11378	Fe 360 D		
S275JR EN 10025-2	S275JR	St44-2	AE275 B	S275JR	E28-2					Fe 430 B	43 B	
S275JR AM FCE	S275JR	St44-2	AE275 B	S275JR	E28-2	St4S			11443	Fe 430 B	43 B	14 12-00
S275J0 EN 10025-2	S275J0	St44-3 U	AE275 C	S275J0	E28-3					Fe 430 C	43 C	
S275J0 AM FCE	S275J0	St44-3 U	AE275 C	S275J0	E28-3	(St4V)			11448	Fe 430 C	43 C	
S275J2 EN 10025-2	S275J2			S275J2G4								14 14-01
S275J2 AM FCE	S275J2			S275J2G4			St4SAL		11448			14 14-01
S275J2+N EN 10025-2	S275J2+N	St44-3 N	AE275 D	S275J2G3	E28-4				11448	Fe 430 D	43 D	14 14-00
S275J2+N AM FCE	S275J2+N	St44-3 N	AE275 D	S275J2G3	E28-4	(St4W)			11448	Fe 430 D	43 D	14 14-00
S355JR EN 10025-2	S355JR		AE355 B	S355JR	E36-2					Fe 510 B	50 B	
S355JR AM FCE	S355JR		AE355 B	S355JR	E36-2		(18G2)		11523	Fe 510 B	50 B	
S355J0 EN 10025-2	S355J0	St52-3 U	AE355 C	S355J0	E36-3					Fe 510 C	50 C	
S355J0 AM FCE	S355J0	St52-3 U	AE355 C	S355J0	E36-3				11523	Fe 510 C	50 C	
S355J2 EN 10025-2	S355J2			S355J2G4								
S355J2 AM FCE	S355J2			S355J2G4					11523			
S355J2+N EN 10025-2	S355J2+N	St52-3 N	AE355 D	S355J2G3	E36-4					Fe 510 D	50 D	
S355J2+N AM FCE	S355J2+N	St52-3 N	AE355 D	S355J2G3	E36-4		18G2A		11523	Fe 510 D	50 D	
S355K2 EN 10025-2	S355K2			S355K2G4								
S355K2+N EN 10025-2	S355K2+N			S355K2G3							50 DD	
S355K2+N AM FCE	S355K2+N			S355K2G3							50 DD	

Grades in italics: not included in the standard

	ASTM A1011-01a	JIS G 3101	Old brand names
S185 EN 10025-2			
S235JR EN 10025-2	SS Grade 36	SS 330	

S235JR-CL1 AM FCE	(SS Grade 36)	(SS 330)	
S235J0 EN 10025-2			
S235J0 AM FCE	SS Grade 36	SS 330	
S235J2 EN 10025-2			
S235J2 AM FCE		SS 330	
S235J2+N EN 10025-2			
S235J2+N AM FCE		SS 330	
S275JR EN 10025-2			
S275JR AM FCE	SS Grade 40	SS 400	
S275J0 EN 10025-2			
S275J0 AM FCE	SS Grade 40	SS 400	
S275J2 EN 10025-2			
S275J2 AM FCE	SS Grade 40	SS 400	
S275J2+N EN 10025-2		SS 400	
S275J2+N AM FCE		SS 400	
S355JR EN 10025-2			
S355JR AM FCE	SS Grade 50		
S355J0 EN 10025-2			
S355J0 AM FCE	SS Grade 50		
S355J2 EN 10025-2			
S355J2 AM FCE	SS Grade 50		
S355J2+N EN 10025-2			
S355J2+N AM FCE			
S355K2 EN 10025-2			
S355K2+N EN 10025-2			
S355K2+N AM FCE			
<i>Grades in italics: not included in the standard</i>			
<i>() Closest grade as no fully equivalent grade exists.</i>			

Dimensions

Mill finish

Thickness (mm)	Min width	S185 EN 10025-2, S235JR EN 10025-2, S235JR-CL1 AM FCE, S235J0 EN 10025-2, S235J0 AM FCE	S235J2 EN 10025-2, S235J2 AM FCE	S235J2+N EN 10025-2, S235J2+N AM FCE	S275JR EN 10025-2, S275JR AM FCE, S275J0 EN 10025-2, S275J0 AM FCE	S275J2 EN 10025-2, S275J2 AM FCE	S275J2+N EN 10025-2, S275J2+N AM FCE
		Max width	Max width	Max width	Max width	Max width	Max width
1.50 ≤ th < 1.60	800	1560	1560	1320	1300	1300	1150
1.60 ≤ th < 1.70				1400	1400		1200
1.70 ≤ th < 1.80		1620	1620	1490	1490	1450	1260
1.80 ≤ th < 1.90				1540	1540	1460	1460
1.90 ≤ th < 2.00		1780	1650	1590	1590	1520	1520
2.00 ≤ th < 2.10		1830	1700	1630	1630	1620	1620
2.10 ≤ th < 2.20				1660	1660	1660	1660
2.20 ≤ th < 2.30				1720	1720	1720	1720
2.30 ≤ th < 2.40		1930	1790	1780	1780	1780	1780
2.40 ≤ th < 2.50				1840	2140	1840	1840
2.50 ≤ th < 2.60		1980	1900	1900	1900	1900	1900
2.60 ≤ th < 2.70		2100	2100	2100	2100	2100	2100
2.70 ≤ th < 2.80							
2.80 ≤ th < 2.90							

2.90 ≤ th < 3.00						
3.00 ≤ th < 3.10						
3.10 ≤ th < 3.20						
3.20 ≤ th < 3.30						
3.30 ≤ th < 3.40						
3.40 ≤ th < 15.00	2150	2150	2150	2150	2150	2150
15.00 ≤ th < 16.00						
16.00 ≤ th < 16.10						
16.10 ≤ th < 16.50						
16.50 ≤ th < 19.00						
19.00 ≤ th < 20.00						

Coils in thicknesses greater than 20 mm can also be produced. Please contact us.

Thickness (mm)	Min width	S355JR EN 10025-2, S355JR AM FCE, S355J0 EN 10025-2, S355J0 AM FCE	S355J2 EN 10025-2, S355J2 AM FCE	S355J2+N EN 10025-2, S355J2+N AM FCE, S355K2 EN 10025-2, S355K2+N EN 10025-2, S355K2+N AM FCE			
		Max width	Max width	Max width			
1.50 ≤ th < 1.60	800	1100	1100	-			
1.60 ≤ th < 1.70		1200	1200				
1.70 ≤ th < 1.80		1250	1250				
1.80 ≤ th < 1.90		1300	1300				
1.90 ≤ th < 2.00		1350	1350	1050			
2.00 ≤ th < 2.10		1440	1440	1330			
2.10 ≤ th < 2.20							
2.20 ≤ th < 2.30							
2.30 ≤ th < 2.40					1460	1460	1360
2.40 ≤ th < 2.50							1420
2.50 ≤ th < 2.60					1520	1520	1480
2.60 ≤ th < 2.70					1570	1570	1580
2.70 ≤ th < 2.80					1590	1590	
2.80 ≤ th < 2.90					1630	1630	
2.90 ≤ th < 3.00							
3.00 ≤ th < 3.10		2040	2040	2040			
3.10 ≤ th < 3.20		2080	2080	2080			
3.20 ≤ th < 3.30		2120	2120	2120			
3.30 ≤ th < 3.40		2140	2140	2140			
3.40 ≤ th < 15.00		2150	2150	2150			
15.00 ≤ th < 16.00	1930	1930	1930				
16.00 ≤ th < 16.10							
16.10 ≤ th < 16.50	1740		1740				

16.50 ≤ th < 19.00		1780	
19.00 ≤ th < 20.00			

Coils in thicknesses greater than 20 mm can also be produced. Please contact us.

Pickled

Thickness (mm)	Min width	S185 EN 10025-2, S235JR EN 10025-2, S235JR-CL1 AM FCE, S235J0 EN 10025-2, S235J0 AM FCE, S275J0 EN 10025-2, S275J0 AM FCE	S235J2 EN 10025-2, S235J2 AM FCE	S235J2+N EN 10025-2, S235J2+N AM FCE	S275JR EN 10025-2, S275JR AM FCE	S275J2 EN 10025-2, S275J2 AM FCE	S275J2+N EN 10025-2, S275J2+N AM FCE
		Max width	Max width	Max width	Max width	Max width	Max width
1.50 ≤ th < 1.60	800	1540	1480	1320	1300	1300	1120
1.60 ≤ th < 1.70			1570	1400	1400		1250
1.70 ≤ th < 1.80		1590	1610	1490	1490	1450	1270
1.80 ≤ th < 1.90		1630	1630	1540	1540	1460	1460
1.90 ≤ th < 2.00		1780	1650	1590	1590	1520	1520
2.00 ≤ th < 2.10		1830	1660	1630	1630	1620	1620
2.10 ≤ th < 2.20			1670	1660	1660	1660	1660
2.20 ≤ th < 2.30			1720	1720	1720	1720	1720
2.30 ≤ th < 2.40		1930	1780	1760	1780	1780	1780
2.40 ≤ th < 2.50			1840	1840	1840	1840	1840
2.50 ≤ th < 2.60		1980	1900	1900	1900	1900	1900
2.60 ≤ th < 2.75		2070	2070	2070	2070	2070	2070
2.75 ≤ th < 3.00							
3.00 ≤ th < 3.50							
3.50 ≤ th < 4.00		2130	2130	2130	2130	2130	2130
4.00 ≤ th < 6.35							
6.35 ≤ th < 7.10	1550	1520	1520	1550	1550	1550	
7.10 ≤ th < 7.90							
7.90 ≤ th < 8.00							
8.00 ≤ th < 8.10	1520	1520	1520	1520	1520	1520	
8.10 ≤ th < 13.00							

Thickness (mm)	Min width	S355JR EN 10025-2, S355JR AM FCE	S355J0 EN 10025-2, S355J0 AM FCE	S355J2 EN 10025-2, S355J2 AM FCE	S355J2+N EN 10025-2, S355J2+N AM FCE	S355K2 EN 10025-2, S355K2+N EN 10025-2, S355K2+N AM FCE		
		Max width	Max width	Max width	Max width	Max width		
1.50 ≤ th < 1.60	800	1100	1100	1100	-	-		
1.60 ≤ th < 1.70		1200						
1.70 ≤ th < 1.80		1250						
1.80 ≤ th < 1.90		1300	1280	1270				
1.90 ≤ th < 2.00		1350	1310	1310			1050	1050
2.00 ≤ th < 2.10		1440	1440	1440			1330	1330
2.10 ≤ th < 2.20								

		3-16				-	≥ 24			
		16-20	≥ 225							
S235J2 AM FCE	L	6-20	-	-	-	-	-	-	-	≥ 27
	T	1.5-2	≥ 235	360-510	≥ 17	-	-	-	-	-
		2-2.5			≥ 18					
		2.5-3			≥ 19					
		3-16			-					
	16-20	≥ 225								
S235J2+N EN 10025-2	L	6-20	-	-	-	-	-	-	-	≥ 27
	T	1.5-2	≥ 235	360-510	≥ 17	-	-	-	-	-
		2-2.5			≥ 18					
		2.5-3			≥ 19					
		3-16			-					
	16-20	≥ 225								
S235J2+N AM FCE	L	6-20	-	-	-	-	-	-	-	≥ 27
	T	1.5-2	≥ 235	360-510	≥ 17	-	-	-	-	-
		2-2.5			≥ 18					
		2.5-3			≥ 19					
		3-16			-					
	16-20	≥ 225								
S275JR EN 10025-2	L	6-20	-	-	-	-	-	≥ 27	-	-
	T	1.5-2	≥ 275	430-580	≥ 15	-	-	-	-	-
		2-2.5			≥ 16					
		2.5-3			≥ 17					
		3-16		-	≥ 21					
	16-20	≥ 265	410-560	-						
S275JR AM FCE	L	6-20	-	-	-	-	-	≥ 27	-	-
	T	1.5-2	≥ 275	430-580	≥ 15	-	-	-	-	-
		2-2.5			≥ 16					
		2.5-3			≥ 17					
		3-16		-	≥ 21					
	16-20	≥ 265	410-560	-						
S275J0 EN 10025-2	L	6-20	-	-	-	-	-	-	≥ 27	-
	T	1.5-2	≥ 275	430-580	≥ 15	-	-	-	-	-
		2-2.5			≥ 16					
		2.5-3			≥ 17					
		3-16		-	≥ 21					
	16-20	≥ 265	410-560	-						
S275J0 AM FCE	L	6-20	-	-	-	-	-	-	≥ 27	-
	T	1.5-2	≥ 275	430-580	≥ 15	-	-	-	-	-
		2-2.5			≥ 16					
		2.5-3			≥ 17					
		3-16		-	≥ 21					
	16-20	≥ 265	410-560	-						
S275J2 EN 10025-2	L	6-20	-	-	-	-	-	-	-	≥ 27
	T	1.5-2	≥ 275	430-580	≥ 15	-	-	-	-	-
		2-2.5			≥ 16					
		2.5-3			≥ 17					
		3-16		-	≥ 21					
	16-20	≥ 265	410-560	-						
S275J2 AM FCE	L	6-20	-	-	-	-	-	-	-	≥ 27
	T	1.5-2	≥ 275	430-580	≥ 15	-	-	-	-	-
		2-2.5			≥ 16					
		2.5-3			≥ 17					
		3-16		-	≥ 21					
	16-20	≥ 265	410-560	-						
S275J2+N EN 10025-2	L	6-20	-	-	-	-	-	-	-	≥ 27
	T	1.5-2	≥ 275	430-580	≥ 15	-	-	-	-	-
		2-2.5			≥ 16					
	2.5-3	≥ 17								

		3-16		410-560	-	≥ 21			
		16-20	≥ 265						
S275J2+N AM FCE	L	6-20	-	-	-	-	≥ 27	-	≥ 27
	T	1.5-2	≥ 275	430-580	≥ 15	-	-	-	-
		2-2.5			≥ 16				
		2.5-3			≥ 17				
		3-16	≥ 21						
		16-20	≥ 265	410-560	-	≥ 21			
S355JR EN 10025-2	L	6-20	-	-	-	-	≥ 27	-	-
	T	1.5-2	≥ 355	510-680	≥ 14	-	-	-	-
		2-2.5			≥ 15				
		2.5-3			≥ 16				
		3-16	≥ 20						
		16-20	≥ 345	470-630	-	≥ 20			
S355JR AM FCE	L	6-20	-	-	-	-	≥ 27	-	-
	T	1.5-2	≥ 355	510-680	≥ 14	-	-	-	-
		2-2.5			≥ 15				
		2.5-3			≥ 16				
		3-16	≥ 20						
		16-20	≥ 345	470-630	-	≥ 20			
S355J0 EN 10025-2	L	6-20	-	-	-	-	-	≥ 27	-
	T	1.5-2	≥ 355	510-680	≥ 14	-	-	-	-
		2-2.5			≥ 15				
		2.5-3			≥ 16				
		3-16	≥ 20						
		16-20	≥ 345	470-630	-	≥ 20			
S355J0 AM FCE	L	6-20	-	-	-	-	-	≥ 27	-
	T	1.5-2	≥ 355	510-680	≥ 14	-	-	-	-
		2-2.5			≥ 15				
		2.5-3			≥ 16				
		3-16	≥ 20						
		16-20	≥ 345	470-630	-	≥ 20			
S355J2 EN 10025-2	L	6-20	-	-	-	-	-	-	≥ 27
	T	1.5-2	≥ 355	510-680	≥ 14	-	-	-	-
		2-2.5			≥ 15				
		2.5-3			≥ 16				
		3-16	≥ 20						
		16-20	≥ 345	470-630	-	≥ 20			
S355J2 AM FCE	L	6-20	-	-	-	-	-	-	≥ 27
	T	1.5-2	≥ 355	510-680	≥ 14	-	-	-	-
		2-2.5			≥ 15				
		2.5-3			≥ 16				
		3-16	≥ 20						
		16-20	≥ 345	470-630	-	≥ 20			
S355J2+N EN 10025-2	L	6-20	-	-	-	-	-	-	≥ 27
	T	1.5-2	≥ 355	510-680	≥ 14	-	-	-	-
		2-2.5			≥ 15				
		2.5-3			≥ 16				
		3-16	≥ 20						
		16-20	≥ 345	470-630	-	≥ 20			
S355J2+N AM FCE	L	6-20	-	-	-	-	-	-	≥ 27
	T	1.5-2	≥ 355	510-680	≥ 14	-	-	-	-
		2-2.5			≥ 15				
		2.5-3			≥ 16				
		3-16	≥ 20						
		16-20	≥ 345	470-630	-	≥ 20			
S355K2 EN 10025-2	L	6-20	-	-	-	-	-	-	≥ 40
	T	2-2.5	≥ 355	510-680	≥ 15	-	-	-	-
		2.5-3			≥ 16				
		3-16		470-630	-	≥ 20			

		16 -20	≥ 345	470 - 630	-	≥ 20				
S355K2+N EN 10025-2	L	6 -20	-	-	-	-	-	-	≥ 40	
	T	2 -2.5	≥ 355	510 -680	≥ 15	-	-	-	-	
		2.5 -3								≥ 16
		3 -16								-
	16 -20	≥ 345	470 -630	-	≥ 20	-	-	-		
S355K2+N AM FCE	L	6 -20	-	-	-	-	-	-	≥ 40	
	T	2 -2.5	≥ 355	510 -680	≥ 15	-	-	-	-	
		2.5 -3								≥ 16
		3 -16								-
	16 -20	≥ 345	470 -630	-	≥ 20	-	-	-		

Grades in italics: not included in the standard

Chemical composition

	C (%)	Mn (%)	P (%)	S (%)	Si (%)	Al (%)	Cu (%)	N (%)	C _{eq} (%)	Galvanisation
S185 EN 10025-2	-	-	-	-	-	-	-	-	-	No
S235JR EN 10025-2	≤ 0.17	≤ 1.40	≤ 0.035	≤ 0.035	-	-	≤ 0.55	≤ 0.012	≤ 0.35	No
<i>S235JR-CL1 AM FCE</i>	≤ 0.17	≤ 1.40	≤ 0.025	≤ 0.030	≤ 0.03	≥ 0.010	≤ 0.55	≤ 0.009	≤ 0.35	Class 1
S235J0 EN 10025-2	≤ 0.17	≤ 1.40	≤ 0.030	≤ 0.030	-	-	≤ 0.55	≤ 0.012	≤ 0.35	No
S235J0 AM FCE	≤ 0.17	≤ 1.40	≤ 0.030	≤ 0.030	≤ 0.03	-	≤ 0.55	≤ 0.009	≤ 0.35	Class 1
S235J2 EN 10025-2	≤ 0.17	≤ 1.40	≤ 0.025	≤ 0.025	-	≥ 0.020	≤ 0.55	-	≤ 0.35	No
S235J2 AM FCE	≤ 0.17	≤ 1.40	≤ 0.025	≤ 0.025	≤ 0.03	≥ 0.020	≤ 0.55	-	≤ 0.35	Class 1
S235J2+N EN 10025-2	≤ 0.17	≤ 1.40	≤ 0.025	≤ 0.025	-	≥ 0.020	≤ 0.55	-	≤ 0.35	No
S235J2+N AM FCE	0.130 - 0.170	≤ 1.40	≤ 0.025	≤ 0.020	≤ 0.03	0.015 - 0.070	≤ 0.15	≤ 0.007	≤ 0.35	Class 1
S275JR EN 10025-2	≤ 0.21	≤ 1.50	≤ 0.035	≤ 0.035	-	-	≤ 0.55	≤ 0.012	≤ 0.40	No
S275JR AM FCE	≤ 0.21	≤ 1.50	≤ 0.035	≤ 0.025	-	-	≤ 0.55	≤ 0.012	≤ 0.40	No
S275J0 EN 10025-2	≤ 0.18	≤ 1.50	≤ 0.030	≤ 0.030	-	-	≤ 0.55	≤ 0.012	≤ 0.40	No
S275J0 AM FCE	0.040 - 0.180	≤ 1.50	≤ 0.025	≤ 0.020	≤ 0.03	-	≤ 0.20	≤ 0.009	≤ 0.40	Class 1
S275J2 EN 10025-2	≤ 0.18	≤ 1.50	≤ 0.025	≤ 0.025	-	≥ 0.020	≤ 0.55	-	≤ 0.40	No
S275J2 AM FCE	≤ 0.18	≤ 1.50	≤ 0.025	≤ 0.025	≤ 0.03	≥ 0.020	≤ 0.55	≤ 0.012	≤ 0.40	Class 1
S275J2+N EN 10025-2	≤ 0.18	≤ 1.50	≤ 0.025	≤ 0.025	-	≥ 0.020	≤ 0.55	-	≤ 0.40	No
S275J2+N AM FCE	≤ 0.18	≤ 1.50	≤ 0.025	≤ 0.020	≤ 0.03	≥ 0.020	≤ 0.55	≤ 0.012	≤ 0.40	Class 1
S355JR EN 10025-2	≤ 0.24	≤ 1.60	≤ 0.035	≤ 0.035	≤ 0.55	-	≤ 0.55	≤ 0.012	≤ 0.45	No
S355JR AM FCE	≤ 0.20	≤ 1.60	≤ 0.035	≤ 0.020	≤ 0.50	-	≤ 0.55	≤ 0.009	≤ 0.45	No
S355J0 EN 10025-2	≤ 0.20	≤ 1.60	≤ 0.030	≤ 0.030	≤ 0.55	-	≤ 0.55	≤ 0.012	≤ 0.45	No
S355J0 AM FCE	≤ 0.20	≤ 1.60	≤ 0.025	≤ 0.020	≤ 0.03	0.020 - 0.080	≤ 0.55	≤ 0.009	≤ 0.45	Class 1
S355J2 EN 10025-2	≤ 0.20	≤ 1.60	≤ 0.025	≤ 0.025	≤ 0.55	≥ 0.020	≤ 0.55	-	≤ 0.45	No
S355J2 AM FCE	≤ 0.20	≤ 1.60	≤ 0.025	≤ 0.015	≤ 0.03	0.020 - 0.080	≤ 0.55	≤ 0.009	≤ 0.45	Class 1
S355J2+N EN 10025-2	≤ 0.20	≤ 1.60	≤ 0.025	≤ 0.025	≤ 0.55	≥ 0.020	≤ 0.55	-	≤ 0.45	No
S355J2+N AM FCE	0.120 - 0.200	≤ 1.60	≤ 0.025	≤ 0.015	≤ 0.25	0.020 - 0.080	≤ 0.55	≤ 0.008	≤ 0.45	Class 3
S355K2 EN 10025-2	≤ 0.20	≤ 1.60	≤ 0.025	≤ 0.025	≤ 0.55	≥ 0.020	≤ 0.55	-	≤ 0.45	No
S355K2+N EN 10025-2	≤ 0.20	≤ 1.60	≤ 0.025	≤ 0.025	≤ 0.55	≥ 0.020	≤ 0.55	-	≤ 0.45	No
S355K2+N AM FCE	≤ 0.20	≤ 1.60	≤ 0.025	≤ 0.015	0.15 - 0.25	≥ 0.020	≤ 0.55	≤ 0.009	≤ 0.45	Class 3

Grades in italics: not included in the standard

Values in bold: tighter than the standard

The chemical properties given are based on cast analysis data.

For commercial information (quotations, deliveries, product availability):

- Europe: <http://industry.arcelormittal.com/agencies>
- Other countries: contact@arcelormittal.com

For technical questions about these products: fateurope.technical.assistance@arcelormittal.com

For researchers: [click here](#)

All details provided in the ArcelorMittal Flat Carbon Europe S.A. catalogue are for information purposes only. ArcelorMittal Flat Carbon Europe S.A. reserves the right to change its product range at any time without prior notice.



A34

Indaten[®] atmospheric corrosion resistant steels

When used uncoated and exposed to bad weather, a protective oxide layer develops on the steel surface. That is why this steel is often called "the weathering steel".

Last update: 2014-4-28



Properties

Indaten[®] 355 is a range of steels with improved resistance to atmospheric corrosion that meet the requirements of the EN 10025-5:2004 standard. These grades are fine-grain, high-strength structural steels that have been optimised to give improved processing and in-service performance.

The grades as per EN 10025-5 can be supplied:

- Without any special rolling and/or heat treatment requirements. The abbreviated designation of this delivery condition is +AR.
- Following a rolling process in which final forming is carried out within a certain temperature range, producing a material in a condition equivalent to that obtained after normalising, with the result that the specified mechanical properties values are conserved even after normalising treatment. The abbreviated designation of this delivery condition is +N.

Furthermore, option 11c of EN 10025-5 is also available (sheet, plate, strip, wide flats and flats (width < 150 mm) with a nominal thickness ≤ 20 mm shall be suitable for flanging without cracking).

Advantages

With their characteristic colour, Indaten[®] 355 steels are used in architectural projects either to harmonise with the environment or to create a pleasing contrast with other materials, such as stainless steel. When used uncoated and exposed to bad weather, an oxide layer develops on the steel surface, forming a purplish-brown, finely grained patina that bonds very strongly to the steel and protects it. If the patina is damaged, the steel re-oxidises, thus repairing the patina and maintaining the protective barrier. Indaten[®] 355 can also be coated (paint, metallic coatings etc). In the case of coated parts, the protective layer prevents rust propagation under the paint layer.

Experience has shown that the adhesion of organic coatings on Indaten[®] 355 is superior to bonding on other carbon steel grades.

Applications

Indaten[®] 355 has a wide range of applications: architecture, sculpture, engineering structures, smokestacks, freight wagons, silos, containers and pylons. When used uncoated, no maintenance is required and the material will not deteriorate through corrosion.

The effectiveness of the corrosion protection largely depends on the speed of patina formation. For optimum patina formation, Indaten[®] 355 can be used in a non-confined environment, even in the presence of sulphuric fumes. However, it is strongly recommended not to expose Indaten[®] 355 to condensation or repeated soiling, particularly in environments containing free chlorine.

Since 1 July 2013, the Construction Products Regulation (Regulation (EU) No. 305/2011 – CPR) has required that CE marking be affixed to all products delivered in accordance with a harmonised standard (e.g. EN 10025). This CE marking guarantees, for the uses defined in the standard, the properties described in the declaration of performance submitted by the manufacturer.

All of the steels in this data sheet comply with this Regulation.

The corresponding declarations of performance are available on our website at:

<http://dop.arcelormittal.net/index.php>

Weldability

Indaten[®] 355 has excellent weldability with all the usual welding processes thanks to its low carbon content and fine-grained structure.

Shielded metal arc welding (process no. 111, SMAW)

Supplier	Reference	EN ISO	AWS
Esab	OK 73.08*	2560-A /E 46 5 Z B 32	A5.5 /E8018-G
	OK 48.08*	2560-A /E 42 4 B 32 H5	A5.1 /E7018
Lincoln Electric	Conarc 55CT SRP*	499 /E 46 5 Mn1Ni B 32 H5	A5.5 /E8018-W2-H4R
	Conarc 60G**	757 /E 55 4 Z B 32 H5	A5.5 /E9018M-H4
	Conarc 70G**	757 /E 55 4 1NiMo B 32 H5	A5.5 /E9018-G-H4
S.A.F. Air Liquide	Safer CU 56**	499 /E 464 Z B 32 H5	A5.5 /E8018-G
	Safer NF 52**	499 /E 424 B 54 H5	A5.5 /E7028
		499 /E 423 B 74 H5	
	Safer NF 510**	499 /E 423 B 32 H5	A5.5 /E7018
Thyssen	SH Patinax KB**	499 /E 38 3 Z 1 NiCu B 42	A5.5 /E7015-G

* Specific electrode

** Specially adapted electrode

Submerged arc welding (process no. 21, SAW)

The filler materials to be used are the same as those recommended for welding steels with the same mechanical properties. As SAW involves strong inherent dilution, the welds will develop a patina.

The mechanical properties obtained in fusion zones meet the normal mechanical property requirements for the base metal.

Supplier	Reference	EN ISO	AWS
Esab	Fil Autrod 13.36*	756 /S2Ni1Cu	A5.23 /EG
	OK Flux 10.71 and 10.81 to 10.83*		
Lincoln Electric	Fil LNS 163*		
	Flux P230*	760 /S A AB 1 67 AC H5	
	Fil L60**	756 /S1	A5.17 /EL12
	Flux 780**	760 /S A AR/AB 1 78 AC H5	
	Fil L61**	S2Si	A5.17 /EM12K
	Flux 860**	760 /S A AB 1 56 AC H5	
S.A.F. Air Liquide	Fil AS 26**	756 /S1	A5.17 /EL12
	Flux AS 50**	756 /SF 35 0 MS 1 S 1	A5.17 /F6-A0-EL12
	Fil AS 35**	756 /S2	A5.17 /EM12K
	Flux AS 50**	756 /SF 38 0 MS 1 S 2	A5.17 /F7-A0-EM12K
Thyssen	Union Patinax U*	756 /S 42 2 FB S0	A5.23 /F7A2-EG-G
	Flux UV 420 TT /UV 420 TT-LH*	760 /SA FB 1 65 DC /SA FB 1 65 DC H5	

* Specific welding wire/flux couple

** Specially adapted welding wire/flux couple

Gas metal-arc welding (process no. 135, GMAW)

The thin wires used for equivalent carbon steel grades can also be used for Indaten® 355 steels; copper-plated wires deposit more copper on the surface of the welded zone, which contributes to the development of a patina on the welds. The cored wires to be used are also the same as those used for the equivalent carbon-manganese steel grades.

Supplier	Reference	EN ISO	AWS
Esab	OK Autrod 12.51**	440 /G3Si1	A5.18 /ER70S-6
	OK AristoRod 13.29**	12534 /GMn3Ni1CrMo	A5.28 /ER110S-G
Lincoln Electric	LNM 28*	12070 /G465MG3Ni1	A5.28 /ER80S-G
	LNM Ni1**		A5.28 /ER80S-Ni1
S.A.F. Air Liquide	Nertalic 70 A**	440 /G3Si1	A5.18 /ER70S-6
Thyssen	Union Patinax*	440 /G423CGO	A5.18 /ER70S-G

* Specific welding wire

** Specially adapted welding wire

Flux-cored arc welding (process no. 136, FCAW)

The process is suitable for the assembly of thin products with the same welding parameters recommended for equivalent carbon-manganese steel grades. If a filler wire is used, it must be of the same type as the base metal.

Supplier	Reference	EN ISO	AWS
Esab	OK Tubrod 14.01*	17632-A /T 42 2 Z M M 2 H10	A5.18 /E70C-GM
	OK Tubrod 15.00**	758 /T 42 3 B M 2 H5	A5.20 /E71T-5H4
		758 /T 42 3 B C 2 H5	A5.20 /E71T-5MH4
	OK Tubrod 15.17**	758 /T 46 4 1Ni P M 2 H5	A5.29 /E81T1-Ni1M
		758 /T 46 3 1Ni P C 2 H5	
Lincoln Electric	Outershield 500CT-H*	758 /T 50 5 Z P M 2 H5	A5.29 /E81T1-G-H4
S.A.F. Air Liquide	Safdual 31*	758 /T 42 4 B M 2 H5	A5.20 /E71T5
	Safdual 248*	758 /T 46 A Z MM 1 H5	A5.29 /E81T1G-W2M

* Specific welding wire

** Specially adapted welding wire

Recommendations for use

Appearance of the patina

Outdoor use: the patina forms naturally in the open air (over a period of three to four years). Variations in appearance will be observed, depending on the water condensation, evacuation and evaporation conditions. After a few years, the patina will stabilise, even in an industrial, sulphur-containing or rural environment. To ensure optimum patina formation and limit the formation of rust streaks, the oxidation process can be accelerated artificially by first descaling the surface (by sandblasting or shotblasting) and then subjecting it to alternate periods of dry and humid conditions.

Indoor use: to preserve the natural appearance of the material and at the same time avoid powdery oxide deposits that may cause staining, the following three steps are recommended:

- First remove all dusty deposits, stains or surface defects, then apply a chemical treatment to those areas where corrosion has not yet developed
- Clean the surface with water, brush and dry
- Finally, apply a colourless, matt, UV-resistant varnish

Use painted: as the surface has a high reactivity, it is recommended that the first coat of paint be applied on a clean surface immediately after pickling or sandblasting.

The presence of copper in the oxide layer contributes to the formation of a strongly bonded, elastic and compact patina on the surface of Indaten® 355 in the course of the corrosion process. The chromium and nickel contribute to the formation of insoluble alkaline sulphates, which will seal the pores of the oxide layer, thereby protecting the metal from water and oxygen. Silicon, and to a lesser extent phosphorus, also has a favourable effect on corrosion resistance.

Corrosion in a salt spray atmosphere (according to ASTM B117)

Tests were conducted in a chamber at a temperature of 35°C, in a humid atmosphere with a 5% concentration of NaCl. Weight loss was measured after 1000 hours. The sample was weighed before and after the test, and the rust was removed with an acid solution.

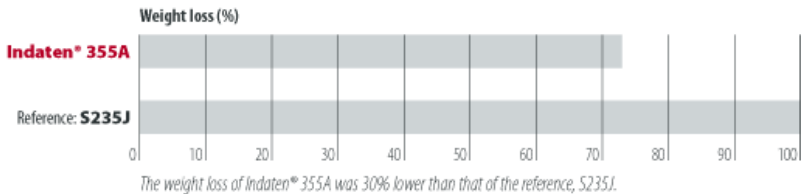

Atmospheric corrosion

The samples were exposed to an industrial, marine atmosphere for 12 months.

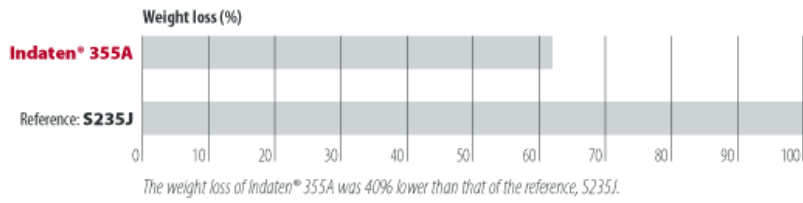

Brand correspondence

	EN 10155:1993	JIS G3114	ASTM	EN 10025-5:2004	Old brand names
S235J0W EN 10025-5				S235J0W	
S235J2W EN 10025-5				S235J2W	
S355J0W EN 10025-5				S355J0W	
S355J0WP EN 10025-5				S355J0WP	
Indaten® 355A	S355J0WP	SMA 50AW	A242 Grade A/A606 T2/A606 T4	S355J0WP	Ensacor® A
S355J2W EN 10025-5				S355J2W	
Indaten® 355D	S355J2W			S355J2W	Ensacor® D
S355J2WP EN 10025-5				S355J2WP	

Dimensions

Mill finish

Thickness (mm)	Min width	S235J0W EN 10025-5, S235J2W EN 10025-5	S355J0W EN 10025-5, S355J2W EN 10025-5, Indaten® 355D	S355J0WP EN 10025-5, Indaten® 355A, S355J2WP EN 10025-5		
		Max width	Max width	Max width		
1.50 ≤ th < 2.00	900	-	1250	1250		
2.00 ≤ th < 2.50		1400		1400		
2.50 ≤ th < 3.00		1750	1540	1540		
3.00 ≤ th < 3.50		2050	2050	1700	1700	
3.50 ≤ th < 4.50				1900	1780	
4.50 ≤ th < 5.00				2050	1900	
5.00 ≤ th < 5.50				2130	2130	1990
5.50 ≤ th < 9.50						2130
9.50 ≤ th < 10.00				2050	2050	2030
10.00 ≤ th < 12.00						
12.00 ≤ th < 13.00		1930				
13.00 ≤ th < 16.00		-	-	1780		
16.00 ≤ th < 20.00				1780		

Product can also be supplied pickled on request.

Mechanical properties

	Notes	Direction	Thickness (mm)	R _e (MPa)	R _m (MPa)	A ₈₀ (%)	A 5.65√S ₀ (%)	Bending ratio (th)	KV 0°C (J)	KV -20°C (J)
S235J0W EN 10025-5		L	6-25	-	-	-	-	-	≥ 27	-
		T	1.5-2	≥ 235	360-510	≥ 17	-	-	-	-
			2-2.5			≥ 18				
			2.5-3			≥ 19				
			3-16			-				
16-25	≥ 225	-	-	-						
S235J2W EN 10025-5		L	6-25	-	-	-	-	-	-	≥ 27
		T	1.5-2	≥ 235	360-510	≥ 17	-	-	-	-
			2-2.5			≥ 18				
			2.5-3			≥ 19				
			3-16			-				
16-25	≥ 225	-	-	-						
S355J0W EN 10025-5		L	6-20	-	-	-	-	-	≥ 27	-
		T	1.5-2	≥ 355	510-680	≥ 14	-	-	-	-
			2-2.5			≥ 15				
			2.5-3			≥ 16				
			3-16			-				
16-20	≥ 345	-	-	-						
S355J0WP EN 10025-5		L	6-12	-	-	-	-	-	≥ 27	-
		T	1.5-2	≥ 355	510-680	≥ 14	-	-	-	-
			2-2.5			≥ 15				
			2.5-3			≥ 16				
3-12	-	≥ 20	-	-						
Indaten® 355A	1	L	6-16	-	-	-	-	-	≥ 27	-
		T	1.7-3	≥ 355	510-680	≥ 18	-	≥ 1.5	-	-
			3-10		490-630	-	≥ 22	≥ 2	-	-
10-16	-	-	≥ 3	-	-					
S355J2W EN 10025-5		L	6-20	-	-	-	-	-	-	≥ 27
		T	1.5-2	≥ 355	510-680	≥ 14	-	-	-	-
			2-2.5			≥ 15				
			2.5-3			≥ 16				
			3-16			-				
16-20	≥ 345	-	-	-						
Indaten® 355D		L	5-12.7	-	-	-	-	-	-	≥ 27
		T	1.8-2	≥ 355	510-680	≥ 14	-	-	-	-
			2-2.5			≥ 15				
			2.5-3			≥ 16				
3-12.7	-	≥ 20	-	-						
S355J2WP EN 10025-5		L	6-12	-	-	-	-	-	-	≥ 27
		T	1.5-2	≥ 355	510-680	≥ 14	-	-	-	-
			2-2.5			≥ 15				
			2.5-3			≥ 16				
			3-12			-				

Values in bold: tighter than the standard

1. For impact resistance at lower temperatures, please check with ArcelorMittal technical representative.

Chemical composition

	C (%)	Mn (%)	P (%)	S (%)	Si (%)	Al (%)	Cu (%)	Cr (%)	Ni (%)	Mo (%)	N (%)	C _{eq} (%)	Galvanisation
S235J0W EN 10025-5	≤ 0.130	0.20-0.60	≤ 0.035	≤ 0.035	≤ 0.40	≥ 0.020	0.25-0.55	0.40-0.80	≤ 0.65	-	≤ 0.009	≤ 0.44	No
S235J2W EN 10025-5	≤ 0.130	0.20-0.60	≤ 0.035	≤ 0.030	≤ 0.40	≥ 0.020	0.25-0.55	0.40-0.80	≤ 0.65	-	≤ 0.009	≤ 0.44	No
S355J0W EN 10025-5	≤ 0.160	0.50-1.50	≤ 0.035	≤ 0.035	≤ 0.50	≥ 0.020	0.25-0.55	0.40-0.80	≤ 0.65	≤ 0.30	≤ 0.009	≤ 0.52	No
S355J0WP EN 10025-5	≤ 0.120	≤ 1.00	0.060-0.150	≤ 0.035	≤ 0.75	≥ 0.020	0.25-0.55	0.30-1.25	≤ 0.65	-	≤ 0.009	≤ 0.52	No
Indaten® 355A	≤ 0.120	≤ 1.00	0.060-0.150	≤ 0.015	0.20 - 0.50	≥ 0.020	0.25-0.55	0.40 - 0.80	≤ 0.30	-	≤ 0.009	≤ 0.45	No
S355J2W EN 10025-5	≤ 0.160	0.50-1.50	≤ 0.030	≤ 0.030	≤ 0.50	≥ 0.020	0.25-0.55	0.40-0.80	≤ 0.65	≤ 0.30	≤ 0.009	≤ 0.52	No

Indaten® 355D	≤ 0.160	0.50 -1.50	≤ 0.030	≤ 0.030	≤ 0.50	≥ 0.020	0.25 -0.55	0.40 -0.80	≤ 0.65	≤ 0.30	≤ 0.009	≤ 0.52	No
S355J2WP EN 10025-5	≤ 0.120	≤ 1.00	0.060 -0.150	≤ 0.030	≤ 0.75	≥ 0.020	0.25 -0.55	0.30 -1.25	≤ 0.65	-	≤ 0.009	≤ 0.52	No
<i>Values in bold: tighter than the standard</i>													

The chemical properties given are based on cast analysis data.

For Indaten® 355D, Zr ≤ 0.15%

For commercial information (quotations, deliveries, product availability):

- Europe: <http://industry.arcelormittal.com/agencies>
- Other countries: contact@arcelormittal.com

For technical questions about these products: flateurope.technical.assistance@arcelormittal.com

For researchers: [click here](#)

All details provided in the ArcelorMittal Flat Carbon Europe S.A. catalogue are for information purposes only. ArcelorMittal Flat Carbon Europe S.A. reserves the right to change its product range at any time without prior notice.



A40

Steels for laser cutting

These steels are particularly suitable for manufacturing complex parts or for improving productivity when parts are to be produced on a small scale.

Last update: 2014-4-28



Properties

Steels for laser cutting are hot rolled steel grades developed for applications using computer controlled thermal and mechanical cutting equipment (laser, plasma etc).

Two ranges are available: structural and High Strength Low Alloy steels.

- The structural steel range begins with S200 Laser AM FCE grade, which combines the drawability of DD12 AM FCE (EN 10111:2008) and the narrow tolerance range for the mechanical properties. All the other grades are improved structural steels in compliance with EN 10025-2:2004.
- The High Strength Low Alloy range comprises improved versions of S315MC, S355MC and S420MC as per EN 10149-2:2013.

All these grades are designed to:

- Give improved productivity, quality and consistency with laser cutting
- Meet the most stringent flatness requirements after cutting

Advantages

Steel coils supplied for laser cutting are virtually free of internal stresses and can therefore be used to produce sheets with guaranteed flatness before, during and after cutting, provided that appropriate decoiling tools and procedures are used. Sheets produced on cutting-to-length lines certified by ArcelorMittal may have guaranteed flatness before, during and after cutting, depending on the level of guarantee chosen: Classic or Premium. These steels can be hot dip galvanised and meet a narrow tolerance range for the mechanical properties.

Applications

These grades are particularly suitable for manufacturing complex parts or for improving productivity when parts are to be produced on a small scale.

Since 1 July 2013, the Construction Products Regulation (Regulation (EU) No. 305/2011 – CPR) has required that CE marking be affixed to all products delivered in accordance with a harmonised standard (e.g. EN 10025). This CE marking guarantees, for the uses defined in the standard, the properties described in the declaration of performance submitted by the manufacturer.

The S240 Laser AM FCE, S275 Laser AM FCE, S355 Laser AM FCE steels in this data sheet comply with this Regulation.

Recommendations for use

For thicknesses below 16 mm, steels for laser cutting offer significantly higher laser cutting speeds than those obtained with standard grades or conventional cutting processes (plasma, oxy-cutting).

Surface quality

Laser cutting speed largely depends on surface homogeneity and reflectivity. To improve productivity for our clients, ArcelorMittal has developed several surface finishes compatible with laser cutting:

- Mill finish:
 - Surface appearance: only A (unexposed) is available
 - Protection: a rolled surface finish is available for all grades and thicknesses
- Pickled:
 - ArcelorMittal's hydrochloric acid pickling process produces a clean, more favourable surface for laser cutting than that produced by sulphuric acid pickling.
 - Surface appearance A (unexposed) and B (exposed) are available
 - Protection:
 - Protective oil may be applied
 - Easyfilm® HPE is available. It offers more uniform dry surface protection than oil and favourably reduces the reflectivity of the steel. Moreover, since no oil is used, workplace floors are cleaner and safer.

Weldability

Thanks to its low carbon equivalent value (see table of chemical properties), ArcelorMittal's steels for laser cutting offer excellent weldability.

Fatigue resistance

The fatigue resistance of S240 Laser AM FCE, S360MC Laser AM FCE and S420MC Laser AM FCE grades has been established by means of the Manson Coffin test, consisting of an alternating tensile test with fixed total deformation. The test is stopped when the load required to obtain this deformation has dropped by 40% of the basic load required at the beginning of the test.

Please contact us for further information.

Mechanical properties

The narrow tolerance range for the mechanical properties guarantees consistent processing performance and reduces springback after laser cutting.

Brand correspondence

High Strength Low Alloy steels

	EN 10025-2:2004	EN 10149-2:2013	EN 10111:2008	Old brand names
S320MC Laser AM FCE		S315MC		
S360MC Laser AM FCE		S355MC		Sollaser [®] 380/Sidlaser [®] 380/Superlaser 355MC
S420MC Laser AM FCE		S420MC		Sollaser [®] 440/Sidlaser [®] 420

Structural steels

	EN 10025-2:2004	EN 10149-2:2013	EN 10111:2008	Old brand names
S200 Laser AM FCE			DD12	Sollaser [®] 220/Sidlaser [®] 220/Superlaser DD12
S240 Laser AM FCE	S235J0			Sollaser [®] 260/Sidlaser [®] 240/Superlaser 235
S275 Laser AM FCE	S275J0			
S355 Laser AM FCE	S355J0			

Dimensions

Thickness tolerance

The consistent thickness and reduced internal stresses of ArcelorMittal laser grades make it possible to operate laser cutting machines continuously by lowering the breakdown risk and the frequency of laser cutting head breakage. This allows the use of fully automated loading and discharging systems.

The following thickness tolerances (EN 10051:2010) are available: 3/4, 1/2 and 1/3 for both mill finish and pickled steels.

Flatness tolerance

Since the degree of sheet flatness obtained mainly depends on the uncoiling and levelling process used during laser cutting, we cannot offer any guarantee for coil products supplied.

With regard to sheets, two products are available, depending on the level of guarantee required:

- Laser Classic
- Laser Premium

All the types of guarantee available are summarised in the following table:

	Grade S___ Laser AM FCE	Laser Classic	Laser Premium
Level of guarantee	Delivery in coils	Delivery in sheets	
Standard	Improved cutting performance Narrower tolerances		
For coils	Reduced internal stresses (guaranteed by observing a specific, certified and closely monitored plant procedure)		
For sheets		Maximum deviation: the minimum value, depending on the circumstances, between 4 mm/m or 8 mm/2 m or 12 mm/3 m and the special tolerances in EN 10051:2010	Maximum deviation: the minimum value, depending on the circumstances, between 3 mm/m or 6 mm/2 m or 9 mm/3 m and the special tolerances in EN 10051:2010
On cut parts		Maximum deviation of 5 mm over a length of 1 m	Maximum deviation of 3 mm over a length of 1 m

Dimension tables

The following tables show the dimensions available for ArcelorMittal's coils and Laser Classic or Premium sheets:

Mill finish

Thickness (mm)	Min width	S200 Laser AM FCE	S240 Laser AM FCE	S275 Laser AM FCE	S355 Laser AM FCE	S320MC Laser AM FCE	S360MC Laser AM FCE	S420MC Laser AM FCE					
		Max width	Max width	Max width	Max width	Max width	Max width	Max width					
2.00 ≤ th < 2.50	700	1550	1630	1630	1440	1240	-	-					
2.50 ≤ th < 3.00		1980	1830	1830		1370	1410	1410					
3.00 ≤ th < 3.50		2000	2030	2050	1800	1600	1600	1600					
3.50 ≤ th < 4.00		2130	2130	2130	2130	1740	1730	1690					
4.00 ≤ th < 4.50						1880	1880	1840					
4.50 ≤ th < 5.00						2030	2050						
5.00 ≤ th < 10.00		2130	2130	2130	2130	2130	2130	2130					
10.00 ≤ th < 12.50									2130	2130	2130		
12.50 ≤ th < 13.00												1930	1920
13.00 ≤ th < 13.50													
13.50 ≤ th < 14.00													
14.00 ≤ th < 15.00													
15.00 ≤ th < 15.50						1930	-	-	-				
15.50 ≤ th < 16.00													

Pickled coils

Thickness (mm)	Min width	S200 Laser AM FCE, S240 Laser AM FCE	S275 Laser AM FCE	S355 Laser AM FCE	S320MC Laser AM FCE	S360MC Laser AM FCE	S420MC Laser AM FCE
		Max width	Max width	Max width	Max width	Max width	Max width
2.00 ≤ th < 2.50	600	1630	1530	1450	1420	1380	-
2.50 ≤ th < 3.00	700	1850	1730	1540	1590	1550	1390
3.00 ≤ th < 4.00		2000	2000	1780	1700	1580	1540
4.00 ≤ th < 5.00		2130	2130	2130	2130	1880	1830
5.00 ≤ th < 6.15						2130	2130
6.15 ≤ th < 7.15		1700	1550	1550	1520		
7.15 ≤ th < 8.15		1550	1550				
8.15 ≤ th < 12.00		1520	1520				
12.00 ≤ th < 13.00		-	-	1520	1520	1520	1520

Dry sheets: Laser Classic

Thickness (mm)	Min width	S200 Laser AM FCE, S240 Laser AM FCE	S275 Laser AM FCE	S355 Laser AM FCE	S320MC Laser AM FCE	S360MC Laser AM FCE	S420MC Laser AM FCE	
		Max width	Max width	Max width	Max width	Max width	Max width	
2.50 ≤ th < 3.00	700	1500	1500	1410	1500	1410	1410	
3.00 ≤ th < 3.50		2050	2050	1650	1870	1980	1500	
3.50 ≤ th < 4.00		2100	2100	2100	1750	2000	2000	1650
4.00 ≤ th < 4.50					1900			1800
4.50 ≤ th < 5.00					2050	2050	2050	
5.00 ≤ th < 10.00		2100	2100	2100	2100	2100	2100	2100
10.00 ≤ th < 12.50					2050			2050
12.50 ≤ th < 13.00					1850			1650
13.00 ≤ th < 13.50								
13.50 ≤ th < 14.00						1740	1850	

14.00 ≤ th < 15.00					1740	
15.00 ≤ th < 15.50					1560	-
15.50 ≤ th < 16.00			-	-	1460	

Pickled sheets: Laser Classic

Thickness (mm)	Min width	S200 Laser AM FCE, S240 Laser AM FCE	S275 Laser AM FCE	S355 Laser AM FCE, S320MC Laser AM FCE, S360MC Laser AM FCE	S420MC Laser AM FCE	
		Max width	Max width	Max width	Max width	
2.50 ≤ th < 3.00	700	1500	1500	1500	1280	
3.00 ≤ th < 3.50						1500
3.50 ≤ th < 4.00						1520
4.00 ≤ th < 4.50		2000	2000	2000		
4.50 ≤ th < 5.00						
5.00 ≤ th < 6.15						
6.15 ≤ th < 7.15						
7.15 ≤ th < 8.15		1550	1550			
8.15 ≤ th < 10.00		1520			1520	
10.00 ≤ th < 12.00						
12.00 ≤ th < 13.00						

Dry sheets: Laser Premium

Thickness (mm)	S200 Laser AM FCE, S240 Laser AM FCE, S275 Laser AM FCE		S355 Laser AM FCE, S360MC Laser AM FCE		S320MC Laser AM FCE		S420MC Laser AM FCE			
	Min width	Max width	Min width	Max width	Min width	Max width	Min width	Max width		
2.50 ≤ th < 3.00	600	1500	600	1500	600	1500	600	1500		
3.00 ≤ th < 5.00		2000		1800						
5.00 ≤ th < 5.50		1600		1600					1600	
5.50 ≤ th < 6.00				1200		1200				
6.00 ≤ th < 6.50				1200		1600	1200	1600	1300	
6.50 ≤ th < 8.50		600		2000		600	1800	600	1800	600
8.50 ≤ th < 10.50	1600		1600		-		-			
10.50 ≤ th < 12.50									-	-
12.50 ≤ th < 13.50										
13.50 ≤ th < 15.50	-		-		-		-			

Pickled sheets: Laser Premium

Thickness (mm)	Min width	S200 Laser AM FCE, S240 Laser AM FCE, S275 Laser AM FCE	S355 Laser AM FCE, S320MC Laser AM FCE, S360MC Laser AM FCE	S420MC Laser AM FCE
		Max width	Max width	Max width
2.50 ≤ th < 3.00	600	1500	1500	1500
3.00 ≤ th < 6.00		2000	1800	
6.00 ≤ th < 8.00		1500	1500	

Mechanical properties

High Strength Low Alloy steels

	Direction	Thickness (mm)	R _e (MPa)	R _m (MPa)	A ₈₀ (%)	A 5.65√S ₀ (%)	Bending ratio (th)	KV 0°C (J)	KV -20°C (J)
S320MC Laser AM FCE	L	2-3	320-420	420-500	≥ 22	≥ 27	-	-	-
		3-6			-				≥ 40
		6-14			-				-
	T	2-3	345-450	435-540	≥ 21	≥ 26	≥ 0	-	-
		3-14			-				-
		-			-				-
S360MC Laser AM FCE	L	2-3	360-440	450-530	≥ 21	-	-	-	-
		3-6			-	≥ 26			-
		6-16			-	≥ 40			-
	T	2-3	380-460	460-540	≥ 20	-	≥ 0.2	-	-
		3-16			-	≥ 25			-
		-			-	-			-
S420MC Laser AM FCE	L	2-3	420-500	490-590	≥ 18	-	-	-	-
		3-6			-	≥ 23			-
		6-14			-	≥ 40			-
	T	2-3	440-520	500-600	≥ 17	-	≥ 0.5	-	-
		3-14			-	≥ 22			-
		-			-	-			-

Structural steels

	Direction	Thickness (mm)	R _e (MPa)	R _m (MPa)	A ₈₀ (%)	A 5.65√S ₀ (%)	Bending ratio (th)	KV 0°C (J)	KV -20°C (J)
S200 Laser AM FCE	T	2-3	200-310	320-410	≥ 27	-	-	-	-
		3-16	200-300	320-400	-	≥ 32			
S240 Laser AM FCE	L	6-16	-	-	-	-	-	≥ 27	-
	T	2-3	240-320	360-440	≥ 22	-	-	-	-
		3-16			-	≥ 28			
S275 Laser AM FCE	L	6-16	-	-	-	-	-	≥ 27	-
	T	2-2.5	≥ 275	430-580	< 16	-	-	-	-
		2.5-3			< 17				
		3-16			-	< 21			
S355 Laser AM FCE	L	6-16	-	-	-	-	-	≥ 27	-
	T	2-2.5	≥ 355	510-610	≥ 15	-	≥ 1	-	-
		2.5-3			≥ 16				
		3-16			-	≥ 20			

Chemical composition

High Strength Low Alloy steels

	C (%)	Mn (%)	P (%)	S (%)	Si (%)	Al (%)	Cu (%)	Cr (%)	Ni (%)	Nb (%)	C _{eq} (%)	Galvanisation
S320MC Laser AM FCE	≤ 0.100	≤ 1.30	≤ 0.025	≤ 0.012	≤ 0.03	≥ 0.020	≤ 0.25	≤ 0.15	≤ 0.25	≤ 0.040	-	Class 1
S360MC Laser AM FCE	≤ 0.110	≤ 1.40	≤ 0.020	≤ 0.012	≤ 0.03	≥ 0.020	≤ 0.25	≤ 0.15	≤ 0.25	≤ 0.050	-	Class 1
S420MC Laser AM FCE	≤ 0.120	≤ 1.60	≤ 0.020	≤ 0.012	≤ 0.03	≥ 0.020	≤ 0.25	≤ 0.15	≤ 0.25	≤ 0.065	-	Class 1

Structural steels

	C (%)	Mn (%)	P (%)	S (%)	Si (%)	Al (%)	Cu (%)	Cr (%)	Ni (%)	Nb (%)	C _{eq} (%)	Galvanisation
S200 Laser AM FCE	≤ 0.080	≤ 0.45	≤ 0.025	≤ 0.025	≤ 0.03	≥ 0.020	-	-	-	-	≤ 0.16	Class 1
S240 Laser AM FCE	≤ 0.170	≤ 0.80	≤ 0.025	≤ 0.025	≤ 0.03	≥ 0.020	≤ 0.25	-	-	-	≤ 0.35	Class 1
S275 Laser AM FCE	≤ 0.180	≤ 1.30	≤ 0.025	≤ 0.025	≤ 0.03	≥ 0.020	≤ 0.25	≤ 0.15	≤ 0.25	-	≤ 0.40	Class 1
S355 Laser AM FCE	≤ 0.200	≤ 1.60	≤ 0.025	≤ 0.012	≤ 0.03	≥ 0.020	≤ 0.25	≤ 0.15	≤ 0.25	≤ 0.060	≤ 0.45	Class 1

For commercial information (quotations, deliveries, product availability):

- Europe: <http://industry.arcelormittal.com/agencies>
- Other countries: contact@arcelormittal.com

For technical questions about these products: fateurope.technical.assistance@arcelormittal.com

For researchers: [click here](#)

All details provided in the ArcelorMittal Flat Carbon Europe S.A. catalogue are for information purposes only. ArcelorMittal Flat Carbon Europe S.A. reserves the right to change its product

range at any time without prior notice.

A90

Floor plates

The embossed teardrop pattern gives these stairs excellent anti-slip properties, irrespective of whether the environment is dry, greasy or damp. Moreover, the pattern is almost indestructible.

Last update: 2014-4-28



Properties

Floor plates are embossed steels with a diamond or teardrop pattern on the surface. The steel used is generally structural steel according to the EN 10025 standard.

For floor plates with a diamond pattern, ArcelorMittal has a specific grade, S235DIAMOND, which guarantees only the chemical compositions required for S235JR according to EN 10025-2:2004.

For floor plates with a teardrop pattern, ArcelorMittal also offers other grades, including:

- High Strength Low Alloy grades (EN 10149-2:2013)
- Structural steel and high strength grades in accordance with American standards

Different patterns are available, including those in line with certain national standards in Europe, the most common of which are:

- Diamond pattern according to DIN 59220:2000 pattern R
- Teardrop pattern according to DIN 59220:2000 pattern T
- Teardrop pattern according to American standard ASTM A786 pattern 4

Diamond pattern

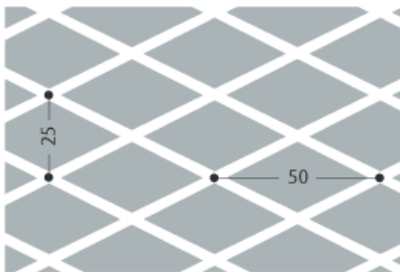

The height of the checkerboard/diamond pattern is between 1 and 2 mm.

DIN 59220:2000 teardrop pattern

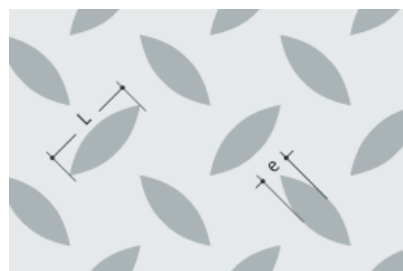

L: approximately 30 mm

e: approximately 10 mm

h: 1 to 2 mm except for core thickness of less than 2.5 mm for which h may vary between 0.5 and 2 mm.

ASTM teardrop pattern

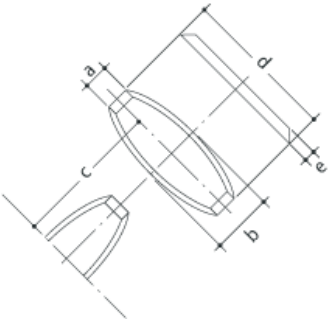

- a = 3.6 mm
- b = 9 mm (-0 + 1.7)
- c = 22.7 mm
- d = 23.3 mm (-0 + 3.8)
- e = 1 to 2 mm (depending on core thickness)

Advantages

The embossed relief gives the floor plate anti-slip properties, irrespective of whether the environment is dry, greasy or damp. Moreover, it is an extremely hardwearing surface that provides excellent resistance to wear due to abrasion, impact and the passage of vehicles, and is also popular with designers for decorative use.

On request, ArcelorMittal's embossed floor plate is also available in Indaten® 355A, which is a weathering grade with good atmospheric corrosion resistance (see data sheet A34).

Applications

Floor plates are mainly used for:

- Floors in buildings, railway carriages and lifts
- Points of access (footbridges, staircases, running boards)
- Roadbeds and slopes
- Ship decks (depending on Lloyds grade)
- Many different applications in the building industry, where its aesthetic appeal is greatly appreciated (see Indaten® 355A, data sheet A34)

Recommendations for use

Floor plate may be processed in the same way as smooth sheet of the same quality (bending, forming, welding etc).

Technical properties

Indicative typical weight (kg/m²) as a function of core thickness (e.g. thickness ordered) is given in the table below.

Core thickness (mm)	3	4	5	6	8	10
Weight for teardrop pattern	26	34	42	49	65	81
Weight for diamond pattern	28	36	44	51	67	83

Standards

In order to simplify the presentation of this technical data sheet, we refer to the grades as follows:

- S235J meaning grades S235DIAMOND, S235JR or S235J0 or S235J2 according to EN 10025:2004

- S275J meaning grades S275JR or S275J0 or S275J2 according to EN 10025:2004
- S355J meaning grades S355JR or S355J0 or S355J2 according to EN 10025:2004

The three types of each of these grades are available.

Brand correspondence

S235J
S275J
S355J
S355MC
S500MC
Lloyds Grade A

Dimensions

ArcelorMittal's floor plates are supplied in as-rolled condition with mill edge. Cut edge (sheared edge) coil can be supplied for certain patterns, grades and dimensions.

Maximum dimensions for diamond floor plates

- Width between 1000(-0/+20) mm and 1500(-0/+20) mm
- Thickness between 2 and 12.7 mm

Maximum dimensions for teardrop floor plates

Thickness (mm)	Min width	S235J	S275J	S355J	S355MC	S500MC	Lloyds Grade A	
		Max width	Max width	Max width	Max width	Max width	Max width	
1.60 ≤ th < 1.80	800	1010	-	-	-	-	-	
1.80 ≤ th < 1.90		1030						
1.90 ≤ th < 2.00		1250	1250	-	-	-	1250	
2.00 ≤ th < 2.50								
2.50 ≤ th < 2.95		1520	1540	-	-	-	1540	
2.95 ≤ th < 3.00		1880						
3.00 ≤ th < 3.10		2020	2020	1500	1595	1345	1730	
3.10 ≤ th < 3.50		2030	2030	1535				
3.50 ≤ th < 4.00		2070	2070	1675				
4.00 ≤ th < 4.50		2100	2100	1845				
4.50 ≤ th < 4.75		2120	2120	2125	1650	1445	2130	
4.75 ≤ th < 5.00		2135	2135	2030	2030			
5.00 ≤ th < 5.75				2135	1790			2000
5.75 ≤ th < 6.00					2135			2135
6.00 ≤ th < 12.00				2135		2135	2135	
12.00 ≤ th < 13.00								
13.00 ≤ th < 14.00								
14.00 ≤ th < 15.00								
15.00 ≤ th < 20.00								

In view of the specific nature of this range, do not hesitate to contact us to enable us to examine each of your specific requirements.

Chemical composition

	Galvanisation
S235J	
S275J	
S355J	
S355MC	Class 1
S500MC	Class 1
Lloyds Grade A	

For details about guaranteed values, refer to the corresponding tables in data sheets A20, A30 and H63.

For commercial information (quotations, deliveries, product availability):

- Europe: <http://industry.arcelormittal.com/agencies>
- Other countries: contact@arcelormittal.com

For technical questions about these products: fateurope.technical.assistance@arcelormittal.com

For researchers: [click here](#)

All details provided in the ArcelorMittal Flat Carbon Europe S.A. catalogue are for information purposes only. ArcelorMittal Flat Carbon Europe S.A. reserves the right to change its product range at any time without prior notice.

Packaging

All packaging materials are in accordance with the European directive on the disposal of packaging material (1994/62/EC), which bans material containing heavy metals. We are working in close collaboration with our clients to avoid unnecessary packaging so as to reduce waste to an absolute minimum.

Last update: 2014-12-23

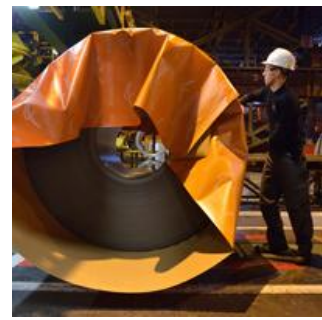

Mill finish			
Transport	Product specification	Packaging code (1)	
Road, rail or inland waterways	$R_e \leq 400$ MPa	H01 (alternative: H02)	
	$400 < R_e \leq 550$ MPa	H03	
	$R_e > 550$ MPa	H05	
Inland waterways, Maritime Continental or Maritime Intercontinental	$R_e \leq 400$ MPa	H03	
	$400 < R_e \leq 550$ MPa	H04	
	$R_e > 550$ MPa	H06	
All means of transport	$R_e > 550$ MPa	H07	
Pickled			
Transport	Product specification	Packaging code (1)	
Road, rail or inland waterways	Oiled products	$R_e \leq 550$ MPa	P01, P02
		$R_e > 550$ MPa	P0A
	Unoiled products	$R_e \leq 550$ MPa	P11 (alternative: P13)
		$R_e > 550$ MPa	P1A (alternative: P1C)
Inland waterways or Adapted Maritime Continental	$R_e \leq 550$ MPa	P21 (alternatives: P22, P16)	
	$R_e > 550$ MPa	P2A (alternatives: P2B, P1F)	
Maritime Continental or Maritime Intercontinental	$R_e \leq 550$ MPa	P24 (alternative: P25)	
	$R_e > 550$ MPa	P2D (alternative: P2E)	

(1) For packaging code definitions, see industry.arcelormittal.com > Services > Supply chain > [Packaging codes and rules](#).

Important warning: the client's attention is drawn to the fact that unpacking the products is a potentially dangerous operation. Appropriate action must be taken to ensure the personal safety of personnel engaged in these operations.

These unpacking operations are performed by the client, under his sole responsibility, and must be executed in accordance with all rules and regulations in force, such as standards, technical notices, professional rules and best practices, and in accordance with the recommendations in the documentation provided by the seller, in whatever form this may be, and under appropriate conditions to ensure that no personal injury or damage to property is sustained.

In all cases, any recommendations and/or any technical advice provided by the seller, before and/or during the unpacking of the products, whether provided verbally, in writing or online, are given in good faith but shall not relieve the client of his obligation to take all appropriate measures to prevent any injury to persons and/or damage to property arising during or as a result of such unpacking operations.

Please visit our website (industry.arcelormittal.com) > Sustainability & Environment > Product safety > [Safety first! Best practices to unpack the products](#) for further information on safety measures when unpacking coils.

When ordering slit coils or sheets, please contact us for further information on packaging definition. For commercial information (quotations, deliveries, product availability):

- Europe: <http://industry.arcelormittal.com/agencies>
- Other countries: contact@arcelormittal.com

For technical questions about these products: fateurope.technical.assistance@arcelormittal.com
For researchers: [click here](#)

All details provided in the ArcelorMittal Flat Carbon Europe S.A. catalogue are for information purposes only. ArcelorMittal Flat Carbon Europe S.A. reserves the right to change its product range at any time without prior notice.